

This file provided by

INFINITY

d a t a c o r p

Switch to Infinity Data Corp for your processing needs! Infinity offers great rates, excellent customer support and a wide range of payment processing solutions.

<http://www.infinitydata.com/>

Call Today!
Sales 1 800 393 6665

ICE 5700 Hardware and Installation Operators Manual

Document Revision A

04-04-2001



The Global Leader in Electronic Transaction Solutions

WORLDWIDE
PAYMENT SOLUTIONS

Hypercom Corporation
2851 West Kathleen Road
Phoenix, Arizona 85053
USA

Corporate Telephone: 602.504.5000
Corporate Fax: 602.866.5380
Corporate Repairs Department: 602.504.5378
Corporate Web Site: www.hypercom.com

Copyright 2001 by Hypercom Corporation.

Printed in the United States of America.

All rights reserved.

This publication is proprietary to Hypercom Corporation and is intended solely for use by Hypercom customers. This publication may not be reproduced or distributed for any purpose without the written permission of Hypercom Corporation.

The information Hypercom furnishes in this publication is believed to be accurate and reliable. However, the corporation assumes no responsibility for its use and reserves the right to make changes to the publication at any time without notice.

This document applies to the Name of Software.

Trademarks

Hypercom and the Hypercom logo are registered trademarks of Hypercom Corporation. Integrated Enterprise Network is a trademark of Hypercom Corporation.

Hypercom has attempted throughout this publication to distinguish proprietary trademarks from descriptive terms by following the capitalization style the manufacturer uses. Every effort was made to supply complete and correct information. Any error in identifying or reflecting any proprietary marks or notices is inadvertent and unintentional.

FCC Part 15 (ICES-003)

This equipment has been tested and found to comply with the limits for a Class A digital device, pursuant to Part 15 of the FCC (ICES-003) Rules. These limits are designed to provide reasonable protection against harmful interference when the equipment is operated in a commercial environment. This equipment generates, uses, and can radiate radio frequency energy, and if not installed and used in accordance with the instruction manual, may cause harmful interference to radio communications. Operation of this in a residential area is likely to cause harmful interference in which case the user will be required to correct the interference at his own expense.

FCC Part 68 Requirements Notice

This equipment complies with Part 68 of the FCC Rules. On the bottom of this equipment is a label that contains the FCC Registration Number and Ringer Equivalence Number (REN) for this equipment. If requested, you must provide this information to your telephone company.

NOTE: REN is not required for some types of analog or digital facilities.

This equipment uses an RJ11 jack.

An FCC-compliant telephone cord and modular plug are provided with this equipment. It is designed to be connected to the telephone network or premises wiring using a compatible modular jack that is Part 68-compliant. See installation instructions for details.

The REN is useful to determine the number of devices you may connect to your telephone line and still have all those devices ring when your telephone number is called. In most but not all areas, the sum of the RENs of all devices connected to one line should not exceed five. To be certain of the number of devices you may connect to your line, contact your local telephone company to determine the maximum REN for your calling area.

NOTE: REN is associated with loop-start and ground-start ports. Do not use for E&M or digital ports.

If your telephone equipment causes harm to the telephone network, the telephone company may discontinue your service temporarily. If possible, they will notify you in advance. However, if advance notice is not practical, you will be notified as soon as possible. You will be informed of your right to file a complaint with the FCC.

Your telephone company may make changes in its facilities, equipment, operations, or procedures that could affect the proper functioning of your equipment. If they do, you will be notified in advance to give you an opportunity to maintain uninterrupted telephone service.

If you experience trouble with this telephone equipment, please contact the Hypercom Repairs Department at (602) 504-5378 for information on obtaining service or repairs. The telephone company may ask that you disconnect this equipment from the network until the problem is corrected or until you are sure that the equipment is not malfunctioning.

This equipment may not be used on coin service provided by the telephone company. Connection to party lines is subject to state tariffs.

This telephone receiver is hearing-aid compatible if applicable.

CTR21

The equipment has been approved to Commission Decision, CTR21, for pan-European single terminal connection to the Public Switched Telephone Network (PSTN). However, due to differences between the individual PSTNs provided in different countries, the approval does not, of itself, give an unconditional assurance of successful operation on every PSTN network termination point. In the event of problems, you should contact your equipment supplier in the first instance.

Industry Canada (IC) Notice

NOTICE: The Industry Canada (IC) label identifies certified equipment. This certification means that the equipment meets telecommunications network protective, operational, and safety requirements as prescribed in the appropriate Terminal Equipment Technical Requirements documents. The department does not guarantee the equipment will operate to the user's satisfaction.

Before installing this equipment, users should ensure that it is permissible to be connection to the facilities of the local telecommunications company. The equipment must also be installed using an acceptable method of connection. The customer should be aware that compliance with the above conditions may not prevent degradation of service in some situations.

Repairs to certified equipment should be coordinated by a representative designated by the supplier. Any repairs or alterations made by a user to this equipment, or any equipment malfunctions, may give the telephone communications company cause to request that the user to disconnect the equipment.

Users should ensure for their own protection that the electrical ground connections of the power utility, telephone lines, and internal metallic water pipe system, if present, are connected together. This precaution may be particularly important in rural areas. **Caution:** Users should not attempt to make such connections themselves, but should contact the appropriate electric inspection authority or electrician, as appropriate.

NOTICE: The Ringer Equivalence Number (REN) assigned to each terminal device provides an indication of the maximum number of terminals allowed to be connected to a telephone interface. The termination on an interface may consist of any combination of devices subject only to the requirement that the sum of the Ringer Equivalence Numbers of all the devices does not exceed five.

Warranty and Repair Service Center:

Hypercom Corp.
2851 W. Kathleen Rd.
Phoenix, AZ 85023

Table of Contents

List of Figures

List of Tables

Introduction

Guide Organization	xiii
Who Should Use This Guide	xiii
Other Documentation	xiii
Guide Conventions	xiv

Chapter 1 Hardware Information

General Safety Precautions	1-2
Security	1-3
Keyboard	1-3
PIN Pad	1-3
Touch-Screen Display	1-4
Magnetic Stripe Read Card Reader	1-4
Check Reader	1-4
Thermal Printer	1-5
Auto Receipt Cutter	1-5
High-Speed Modem	1-5
Memory	1-5
Power Requirements	1-5
Dimensions	1-6

Chapter 2 Installation Procedures

Power-Up the ICE 5700 Terminal	2-1
Connecting the Telephone Line	2-3
Self-Test and Diagnostics	2-4

Chapter 3 Setup Procedures

Configuring the ICE Terminal	3-1
Program Loading the ICE Terminal	3-3
Initialize the ICE Terminal	3-4
Loading Printer Paper	3-5

Chapter 4 Wireless POS Terminal Interface

Function Blocks 4-1

Operation 4-2

 Instructions to the User 4-2

Basic System 4-3

 Basic System Installation 4-3

 Extending Basic Coverage Area 4-4

 Installing Extended Basic Coverage Area 4-5

 Large-Area Coverage 4-6

 Installing Large Area Coverage 4-6

 Installation Examples 4-8

Index

List of Figures

Chapter 1 Hardware Information

Figure 1-1. ICE 5700 terminals	1-1
Figure 1-2. Standard keyboard	1-3
Figure 1-3. Touch-screen display	1-4

Chapter 2 Installation Procedures

Figure 2-1. ICE 5700 power socket	2-1
Figure 2-2. ICE 5700 line port	2-3

Chapter 3 Setup Procedures

Figure 3-1. ICE 5700 printer paper door open	3-5
Figure 3-2. ICE 5700 printer paper installation	3-6

Chapter 4 Wireless POS Terminal Interface

Figure 4-1. Basic configuration	4-3
Figure 4-2. Extending basic coverage	4-4
Figure 4-3. Large area coverage	4-6
Figure 4-4. Premises wiring diagram	4-7
Figure 4-5. Basic system example	4-8
Figure 4-6. Extended basic example	4-9
Figure 4-7. Large area example	4-10

List of Tables

Chapter 1 Hardware Information

Table 1-1. Terminal dimensions	1-6
--------------------------------------	-----

Chapter 2 Installation Procedures

Table 2-1. Self-test and diagnostics with software loaded	2-4
Table 2-2. Memory page states	2-4
Table 2-3. Self-test and diagnostics when software is not loaded	2-5

Introduction

The *ICE 5700 Hardware and Installation Operators Manual* is a comprehensive guide to working with Hypercom® ICE 5700 terminal.

The ICE 5700 terminal is part of the Hypercom Interactive Consumer Environment (ICE) family of touch-screen-based terminals and peripherals. All ICE terminals support traditional terminal functions as well as PIN pad and signature capture functionality. The ICE family employs a modular concept. The basic ICE unit is a multifunction peripheral for either a T7x terminal or ECR. With its printer and modem module attached, it becomes a fully-functional terminal and PIN pad.

Guide Organization

The guide contains the following chapters:

- Chapter 1, Hardware Information: General descriptions of hardware required to operate the ICE 5700 terminal
- Chapter 2, Installation Procedures: Step-by-step instructions for starting the ICE 5700 terminal
- Chapter 3, Setup Procedures: Step-by-step instructions for procedures including configuration, program load, initialization, and paper loading
- Chapter 4, Wireless POS Terminal Interface: Descriptions and step-by-step instructions for operating the 900 MHz wireless POS terminal interface

Who Should Use This Guide

This guide is intended for network administrators-merchants-operators-technicians or those who oversee the configuration and daily maintenance of the various networks.

Other Documentation

When working with the ICE 5700 terminal, the *ICE 5000 PIN Pad Loader Operators Manual* may be useful as reference material.

Guide Conventions

This section provides information to help you understand the procedures and concepts presented in this guide. The following special terms and style conventions are used throughout this document:

Component names: Special bold text highlights certain items including the names of window and dialog box components. This text appears in instructions for specific actions such as clicking buttons, typing in text boxes, and selecting from lists. For example:

From the **Main** tab page of the **Group Definition** dialog box, click **List**.

Emphasis: Emphasis is indicated by indented text. For example:

NOTE: A note contains neutral or positive information supplementing the main text. It is often information that applies only to special cases.

IMPORTANT: Important statements draw attention to information crucial to using the product successfully. Pay special attention to Important statements.

Procedures: Numbered procedures have a special graphic appearing in the margin of the text. The words *Step-by-Step* also appear in bold at the beginning of the procedure. For example:



Step-by-Step

To perform a procedure:

1. Follow the steps outlined in the procedure.
2. Most procedures have at least two steps.
 - a. This is a substep.
 - b. Substeps must be completed in the order given.

Step	Action	Terminal response
1	Follow the steps outlined in the procedure.	
2	Most procedures have at least two steps.	

Clicking with the mouse: This document assumes you are using a mouse or some other pointing device to move within and among windows and dialog boxes. Therefore, when instructions include *clicking* an item, it means you use the mouse to move the cursor onto the desired item. You then click the mouse button to highlight the item or cause an action to occur. For example:

Click the **Totals** check box to activate the online totals feature.

Series of actions: The greater-than sign (>) appears in procedures indicating a series of simple, related actions using the mouse pointer. The resulting action typically starts a utility or opens a dialog box. For example

From the **Term-Master** main menu, click **Network > Definitions'**.

Caution and **Warning** boxes: When you see a Caution or Warning message, read the information promptly and carefully before proceeding. The formats for the boxes follows.

CAUTION

Caution advises that a negative result such as a loss of data may occur.

**WARNING**

Warnings provide information that is essential to the safety of the user, the equipment, or both. Failure to do as instructed may result in physical damage.

1

Hardware Information

This chapter provides important information to properly set up and test both the ICE 5700 terminal. To prevent damage to the POS terminal and possible personal injury, be sure to read this document before installing an ICE terminal.



Figure 1-1. ICE 5700 terminal

General Safety Precautions

This section describes general safety precautions that must be followed to ensure proper installation and maintenance of the POS product family.

CAUTION

Electrical Safety: Observe all normal electrical safety practices when operating any equipment attached to an active power source.

Authorized Service: Only a Hypercom authorized service technician or an authorized repair station can perform equipment servicing, adjustment, maintenance, or repairs on the POS products.

Electrostatic Damage: Before performing any maintenance on POS products, ensure that you wear a static strap and are grounded to the POS products.

To ensure protection of the telecommunications port against lightning damage, this product requires connection to the building protective earthing. Therefore, the integrity of protective earthing must be ensured. Use only the Hypercom provided power supply and power cord. Ensure that power is supplied from a suitable power outlet to the supply when the terminal is connected to the telephone line.



WARNING

Electromagnetic Compatibility: This is a Class A product. In a domestic environment, this product may cause radio interference, in which case the user may be required to take appropriate measures.

Danger of explosion: If the battery is installed incorrectly, it could explode. Replace only with the same or equivalent type recommended by the manufacturer. Dispose of used batteries according to the manufacturer instruction.

警告使用者：
這是甲類的資訊產品，在居住的環境中使用時，可能會造成射頻干擾，在這種情況下，使用者會被要求採取某些適當的對策。

Security

Tamper resistance is provided through the use of intrusion detectors and a secure CPU/RAM module that is housed in a sealed metal case. PIN encryption, MAC-ing, encryption key storage, and management are performed in a separate secure co-processor with its own internal RAM. The ICE 5700 terminal supports as many as four integrated Security Access Modules (SAMs) for various smart card solutions.

Keyboard

The keyboard consists of 12 keys: 10 numeric and 2 control keys.

The keyboard provides:

- Buttons sized to meet various cardholder needs
- Audible signals that notify the cardholder of the action being taken

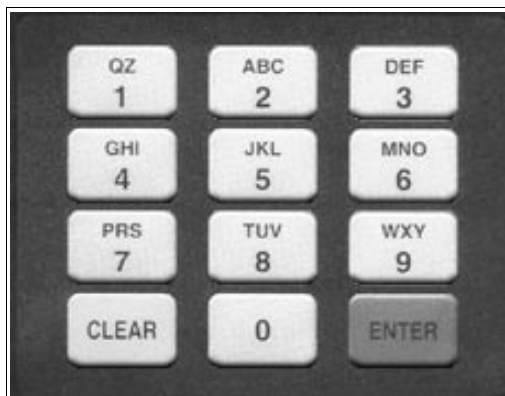

Figure 1-2. Standard keyboard

PIN Pad

The ICE 5700 is a terminal and a PIN pad. The terminal contains all the necessary security features required for secure PIN encryption and message authentication. By allowing transaction entry and PIN entry through the same device, the ICE 5700 reduces cost and footprint. Additionally, the ICE 5700 features a touch-screen. This allows the customer to activate complex applications.

Touch-Screen Display

The ICE 5700 terminal is built around a graphic touch-screen that provides a high degree of flexibility and an intuitive user environment. Additionally, the graphics screen can deliver advertising and other promotional messages directly to the consumer.

The easy-to-operate nature of the touch-screen reduces the need for cashier training. It allows trouble-free operation by consumers in the PIN pad and signature capture pad modes. It also allows the support of complex new applications such as loyalty, which on a traditional terminal requires many keystrokes and long transaction entry times.

For operation in dimly lit environments such as restaurants, the screen is equipped with a backlight.

The standard configuration for the ICE 5700 terminal includes a 1.7 inch by 2.7 inch graphic dot matrix touch screen that is capable of character, graphics, and signature display. While in character mode, the display resolution is 160 pixels by 80 pixels. The character display has 10 lines with 26 characters for each line. Graphic keys displayed on the screen initiate most functions.

NOTE: This display is configurable.

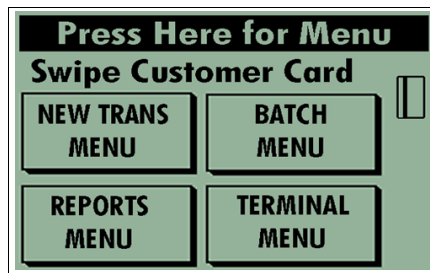

Figure 1-3. Touch-screen display

Magnetic Stripe Read Card Reader

The ICE 5700 magnetic stripe read (MSR) card reader uses Track 1 and 2. Track 3 is optional.

Check Reader

The ICE 5700 motorized check reader magnetically reads the MICR line at the bottom of checks. The terminal supports dial-up to multiple check processors to perform check verification against negative files or check guarantee by obtaining positive online authorization.

Thermal Printer

The ICE 5700 terminal integrates a high-speed, six lines per second, thermal printer that provides quiet and trouble-free operation. Since the thermal printer does not use a ribbon, its support requirement is reduced. The small number of moving parts results in improved reliability.

The thermal paper allows high-quality printing with a long receipt life. When using the correct paper, receipt life or the time before fading exceeds five years.

Auto Receipt Cutter

The most troublesome component of any POS terminal is the printer. The auto receipt cutter on the ICE 5700 is designed to eliminate the need to manually tear the receipt. The first receipt prints and cuts, then the second receipt prints and cuts. Users do not have to manually tear the paper from the terminal, eliminating paper jams.

High-Speed Modem

The ICE 5700 terminal incorporates the new Hypercom FastPOS™ 9600 bps modem. While fully compatible with the current 300, 1200, and 2400 bps modems, the FastPOS modem, when working with a FastPOS network node, provides 9600 bps throughput for transactions, batches, and software downloading.

FastPOS uses a new technology to achieve 9600 bps throughput and 0.5 second training times at a cost that is comparable to the cost of 2400 bps modems.

FastPOS results in faster transactions and lower transaction costs. For example, at a 5-cents-per-minute 800 dial rate, with a 1-second billing interval, a FastPOS transaction costs less than 0.5 cents. More importantly, FastPOS enables large data blocks to be transmitted without a cost penalty. Many of the new opportunities created by the touch screen of the ICE 5700 become more practical when high-speed communications are available.

Memory

The ICE 5700 terminals contain a minimum of 1MB of RAM.

Power Requirements

The power requirements for the ICE terminals are 24VDC, 1A; 85-250 VAC, 50/60 Hz, 15VA.

Dimensions

The dimensions for the ICE 5700 are shown in the following table:

Table 1-1. Terminal dimensions

Terminals	Length	Width	Height
ICE 5700	9.75 in.	7.5 in.	2.25 in.

2

Installation Procedures

This section contains important information that will help properly install ICE 5700 terminal.

Power-Up the ICE 5700 Terminal

Use the following procedures to power up the ICE 5700 terminal.



Step-by-Step

To power up the ICE terminal:

1. Connect the +24 Vdc power cable from the AC Adaptor to the three-pin terminal socket labeled *POWER* on the back panel of the ICE 5700 terminal.
2. Plug the AC Adaptor into a 110-Volt grounded power receptacle. Be sure the connector is firmly seated. When the power is connected successfully, the terminal beeps twice and then performs a self-test and diagnostic routine.

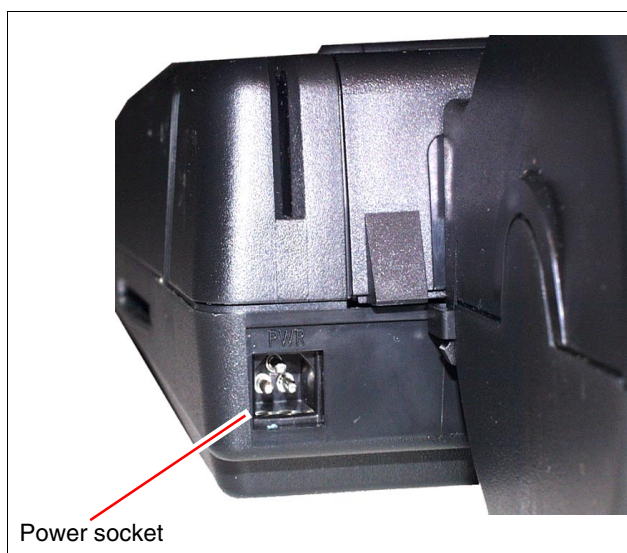

Figure 2-1. ICE 5700 power socket



WARNING

Disconnect the AC electric power before replacing the printer module.

Do not use an adapter, a power extender adapter, a power extender cable, or an AC outlet that does not have a ground connection.

Do not disassemble the AC adapter. Only a qualified service technician should service the adapter.

The AC adapter was designed for indoor use only. Do not expose to rain or snow.

Do not immerse in fluid.

The reliability of electronic equipment is significantly reduced when it is powered from an ungrounded outlet. Power is connected to the terminal through a low-power AC adapter. Connect only one terminal to each AC adapter.

Connecting the Telephone Line

Use the following procedures to connect a telephone line to the ICE 5700 terminal.



Step-by-Step

To connect a telephone line:

1. Insert the telephone cable shipped with the ICE 5700 terminal into a dedicated analog modular telephone receptacle. The use of a different cable might result in improper operation.
2. Insert the other end of the telephone cable into the opening labeled *LINE* on the back panel of the ICE 5700 terminal.
3. Ensure that the telephone line cable latches are firmly locked into the jack on the ICE 5700 terminal and wall receptacle.

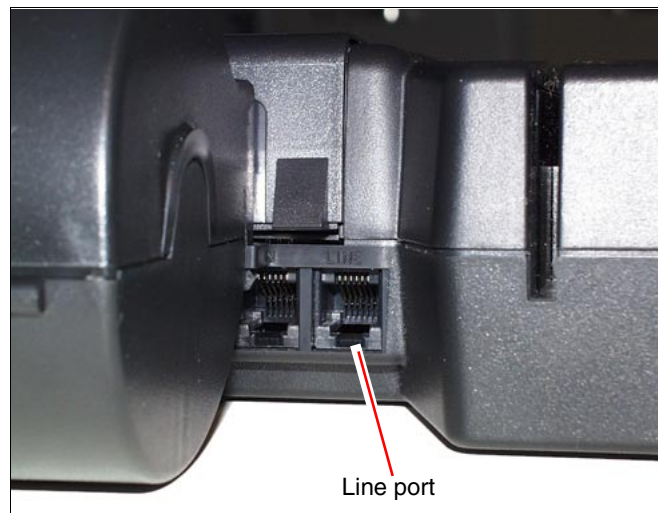

Figure 2-2. ICE 5700 line port



WARNING

Do not insert the telephone line into the PIN pad port.

Self-Test and Diagnostics

Immediately after powering up the terminal, a double beep indicates that the terminal has automatically initiated its self-diagnostic routine.

The software and download status of the terminal is displayed during the self-test, which lasts approximately four seconds.

Table 2-1. Self-test and diagnostics with software loaded

Description	Terminal response
Software: Software name and version. DLL: Tracks the number of downloads. This is controlled by Term-Master. OS: Operating System and version. Terminal: Terminal ID number.	<pre> IDENTIFICATION SOFTWARE XX_XXXXXX DLL 00 OS T5KBOOTXXX TERMINAL NNNNNNNN WAIT SELF TEST </pre>
Installed memory is displayed. The display indicates one megabyte of memory installed.	<pre> MEMORY PAGE STATUS: BOOT: XXXX 01: AAAAAAAAAAFFFFFF 17: FFFFFFFFFFFFFFFF </pre>

A memory page may be in one of the states shown in the following table.

Table 2-2. Memory page states

Status	Description
A	Active: application resident
C	Corrupt: checksum error
F	Free
L	Lost Communication
I	Inactive
U	Unknown
-	No fit: not available for use

If the terminal is not loaded with software, the displays shown in the following table are typical.

Table 2-3. Self-test and diagnostics when software is not loaded

Description	Terminal response
T5KBOOT: Boot program name XXX: Boot program release	<pre> T5KBOOTXXX WAIT SELF TEST </pre>
The memory page status indicates that no program is loaded.	<pre> MEMORY PAGE STATUS: BOOT: XXXX 01: FFFFFFFFFFFFFFFF 17: FFFFFFFFFFFFFFFF </pre>
PE indicates Program Error. In this case, the program is not loaded.	<pre> CONFIGURE TERMINAL or CALL HELP - PE 0: Restart 1: Merchant Programming 2: Program Load 3: Clear Page Memory 4: Maintenance Functions 5: Fast Load </pre>

3

Setup Procedures

This chapter provides setup procedures for the Hypercom ICE 5700 terminal, including the steps necessary for terminal configuration, program load, and initialization. Please refer to the *ICE 5000 PIN Pad Loader Operators Manual* when configuring a terminal for Debit Processing.

Configuring the ICE Terminal

A configuration sets the parameters the ICE 5700 uses to communicate with Term-Master. When the configuration is complete, the terminal is able to receive the terminal application software.



Step-by-Step

To configure the ICE terminal:

Step	Action	Terminal response
	The Idle prompt appears.	CONFIGURE TERMINAL OR CALL HELP - PE 0: RESTART 1: MERCHANT PROGRAMMING 2: PROGRAM LOAD 3: CLEAR PAGE MEMORY 4: MAINTENANCE FUNCTIONS 5: FAST LOAD
1	Touch 1 on the terminal display.	MERCHANT PROGRAMMING TERMINAL ID NUMBER XXXXXXXXXX Q W E R T Y U I O P A S D F G H J K L ← Z X C V B N M SPACE CANCEL CLEAR ENTER

Step	Action	Terminal response
2	Type the terminal ID, then touch Enter on the terminal display, or press Enter on the terminal keyboard.	MERCHANT PROGRAMMING INIT. TELEPHONE NO ← A B C D E F CANCEL CLEAR ENTER
3	Type the initialization number, then touch or press Enter .	MERCHANT PROGRAMMING NMS TELEPHONE NO ← A B C D E F CANCEL CLEAR ENTER
4	Type the NMS number, then touch or press Enter .	MERCHANT PROGRAMMING DIAL 0-TONE 1-PULSE ← A B C D E F CANCEL CLEAR ENTER
5	Type 0 for tone dialing or 1 for pulse dialing, then touch or press Enter .	MERCHANT PROGRAMMING PABX ACCESS CODE ← A B C D E F DEL CANCEL CLEAR ENTER
6	Type a PABX code, if necessary, then touch or press Enter .	MERCHANT PROGRAMMING TERMINAL ID NUMBER XXXXXXXXXX Q W E R T Y U I O P A S D F G H J K L ← Z X C V B N M SPACE CANCEL CLEAR ENTER
7	Touch Cancel .	The terminal displays the Idle prompt.

Program Loading the ICE Terminal

A program load is required when no software is currently in the terminal. Depending on the software application, an average program load takes approximately 40 minutes to complete. The initialization process loads the merchant-specific information in a terminal.

MAC software is required when the ICE 5700 supports debit processing. Please refer to the *ICE 5000 PIN Pad Loader Operators Manual* for further details.



Step-by-Step

To load a program into the ICE terminal:

Step	Action	Terminal response
	The Idle prompt appears.	PLEASE INITIALIZE OR CALL HELP - PE 0: RESTART 1: MERCHANT PROGRAMMING 2: PROGRAM LOAD 3: CLEAR PAGE MEMORY 4: MAINTENANCE FUNCTIONS 5: FAST LOAD
1	Touch 2 on the terminal display.	PROGRAM LOAD CORRECT? YES OR NO CANCEL CLEAR ENTER
2	Touch Enter to continue. The following screens appear.	PROCESSING YOUR REQUEST Please wait and watch for message
	The terminal checks the dial line.	CHECKING LINE
	The terminal dials the host.	WAITING FOR DIAL TONE DIALING NOW
	The terminal waits for the host to answer.	WAITING FOR ANSWER
	The terminal connects to the host.	TRAINING MODEM
	The terminal sends request information to the host.	PROCESSING NOW
	The program load begins.	LOADING MEM XX XXXX

Loading Printer Paper

Use the following procedures to install paper in the ICE 5700 terminal.



Step-by-Step

To load the printer paper in the ICE 5700:

1. Open the printer paper cover on the back of the ICE 5700 printer.



Figure 3-1. ICE 5700 printer paper door open

2. Place the paper roll into the printer paper holder, make sure the printer paper unrolls from under the roll, not over the top, and has a straight-line path into the printer paper-feed mechanism.
3. Place the end of the paper in the paper guide. The printer then automatically feeds the paper. If the printer does not automatically feed the paper, proceed with step 4. Otherwise, proceed to step 10.

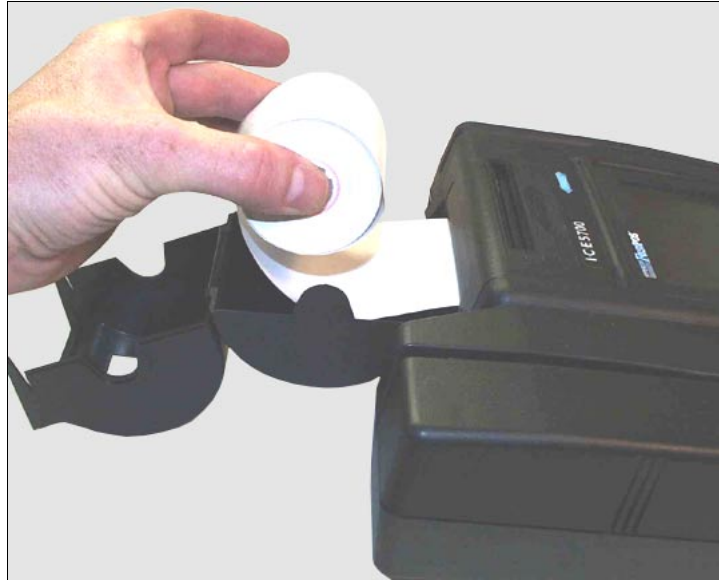

Figure 3-2. ICE 5700 printer paper installation

4. At the main terminal display, touch **Terminal Menu**.
5. Touch the **arrow**. The Terminal Main menu prompt appears.
6. Touch **Setup**. The Setup menu appears.
7. Touch **Printer**. The Printer prompt appears.
8. Touch **Paper Feed**. The Paper Feed menu appears.
9. Touch **Paper Feed** until the paper feeds through the printer tear bar.
NOTE: If the printer fails to advance the paper, you may need to check the printer ON/OFF settings. Complete the following steps to verify the settings.
 - a. At the main terminal display, touch **Terminal Menu**.
 - b. Touch the **arrow**. The Terminal Main menu prompt appears.
 - c. Touch **Setup**. The Setup menu appears.
 - d. Touch **Printer**. The Printer prompt appears.
 - e. Touch **On/Off**. The *Printer Toggle* menu prompt appears. The menu displays *Printer is disabled. Enable?*
 - f. Touch **Yes**. The terminal changes the printer settings to Enabled and returns to the main menu. Repeat steps 4 through 9.
10. Touch **Quit**. The system returns to the main terminal menu.
11. Close the printer paper cover.

4

Wireless POS Terminal Interface

The ICE 5700, 900 MHz wireless POS terminal interface system offers a high level of customer convenience and reduces the time required to process a POS transaction. Because customers see the process, they have control of the financial transaction and feel an added sense of security. The host POS terminal and peripheral POS devices provide data encryption.

Function Blocks

The 900 MHz wireless POS terminal interface consists of the following functional blocks:

- Terminal transceiver interface: Hypercom model FTI01 or for use with a single terminal transceiver, a Hypercom adapter cable, P/N 810170-001.
- Terminal transceiver: Hypercom model FXV01.
- Customer premises wiring: If required.
- Peripheral terminal device: This may be any Hypercom POS terminal or POS terminal accessory such as a PIN pad or electronic receipt capture device, with a compatible optional wireless transceiver installed. An example is an ICE 4000 POS terminal with appropriate software installed.

Operation

The ICE 5700 900 MHz wireless POS terminal interface system is designed to be transparent to the user. The peripheral device operates with a wireless POS terminal interface system in the same way as when a cable connection exists between a peripheral POS device and a host POS terminal.

Instructions to the User

This equipment was tested and found to comply with the limits for a class B digital device, pursuant to part 15 of the FCC Rules. These limits are designed to provide reasonable protection against harmful interference in a residential installation. This equipment generates, uses, and can radiate radio frequency energy. If not installed and used in accordance with the instructions, the equipment may cause harmful interference to radio communications. However, there is no guarantee that interference will not occur in a particular installation. If this equipment does cause harmful interference to radio or television reception, determined by turning the equipment off and on, the user is encouraged to try to correct the interference by one or more of the following measures:

- Reorient or relocate the receiving antenna
- Increase the separation between the equipment and receiver
- Connect the equipment to an outlet on a circuit different from that the receiver is connected to
- Consult the dealer or an experienced radio or TV technician for help

This equipment is certified to comply with the limits for a class B computing device, pursuant to FCC Rules. To maintain compliance with FCC regulations, shielded cables must be used with this equipment. Operation with non-approved equipment or unshielded cables is likely to result in interference to radio and TV reception. The user is cautioned that changes and modifications made to the equipment without the approval of the manufacturer could void user authority to operate this equipment.

This class B digital apparatus meets all requirements of the Canadian Interference-Causing Equipment Regulations.

Basic System

Figure 4-1 shows the basic ICE configuration. The terminal transceiver should be less than 100 feet from the peripheral terminal device. This short range reduces the possibility of interference with other communication systems using the same radio spectrum. Causing such interference is a violation of FCC regulations.

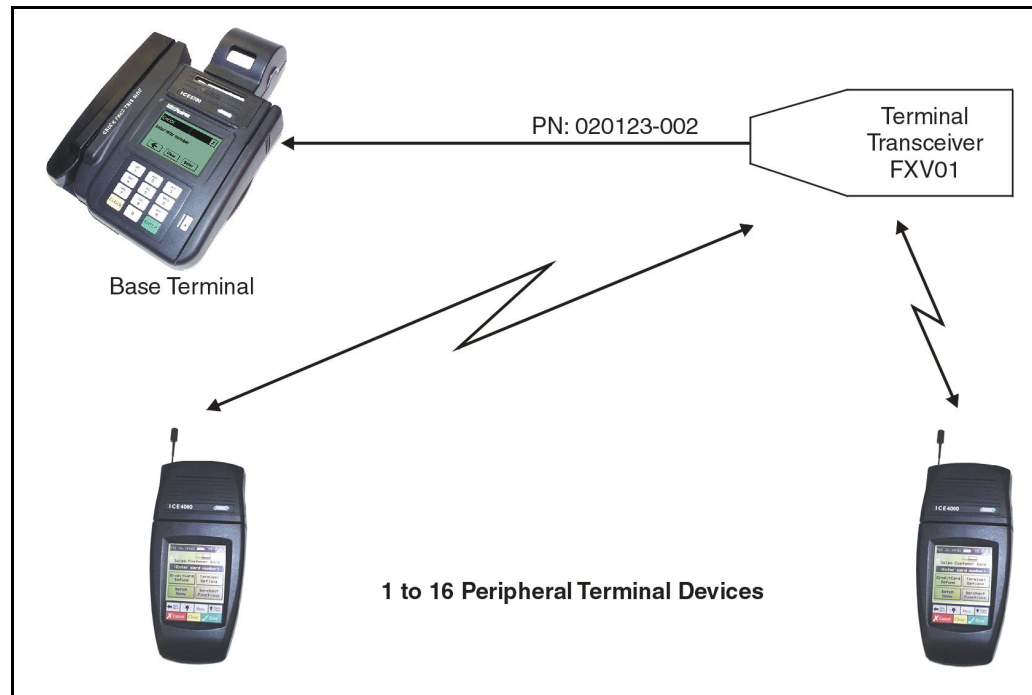

Figure 4-1. Basic configuration

Basic System Installation

Use the following procedure to install the basic system wireless hardware.



Step-by-Step

To install the basic system:

1. Ensure the host terminal is properly configured and connected for use as a standard POS terminal.
See the manual provided with the host POS terminal.
2. Mount the terminal transceiver, Hypercom P/N 020123-002, to a vertical surface. Place it as high as possible in an area that has the best visibility from the area where the peripheral terminal devices are used. You may mount the transceiver by using the metal hook or the rubber suction cups provided. An alternate method is to remove the metal hook and the rubber suction cups, replacing them with double-sided tape. The terminal transceiver must not be mounted on or next to metal objects.

3. Insert the male connector on the 12-foot cable from the terminal transceiver into the female connector on the single-unit adapter cable.

If the 12-foot cable is not long enough, it may be extended up to 100 feet by using any six-conductor, one-to-one standard telephone extender cable available at various electronic appliance retail outlets. The cable may be extended up to 1000 feet by substituting a terminal transceiver interface for the single unit adapter cable.



WARNING

To avoid damaging the terminal transceiver unit, do not insert the cable connectors from the single unit adapter or the terminal transceiver into any receptacle designated for use with the premises telephone system.

Extending Basic Coverage Area

If the basic system does not cover enough space or major gaps exist in the coverage, you can extend the area covered. The example in Figure 4-2 shows how to extend coverage or fill in gaps by adding a terminal transceiver interface and an additional terminal transceiver.

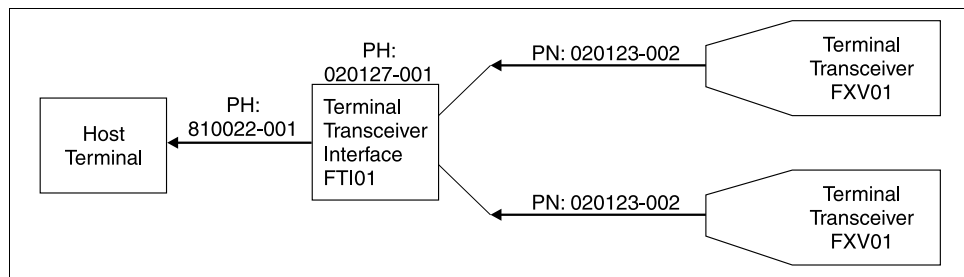

Figure 4-2. Extending basic coverage

Installing Extended Basic Coverage Area

Use this procedure for installing the extended basic coverage wireless hardware.



Step-by-Step

To install the extended basic coverage area:

1. Ensure the host terminal is properly configured and connected for use as a standard POS terminal.
See the manual provided with the host POS terminal.
2. If this is a system upgrade from the basic system, discard the single unit adapter cable. Insert one end of the PIN pad cable, Hypercom P/N 810022-001, into the PIN pad port of the host POS terminal. Insert the other end of the PIN pad cable into the connector marked *To Terminal* on the terminal transceiver interface.
3. Mount the two terminal transceivers, Hypercom P/N 020123-002, to a vertical surface. Place them as high as possible in an area that has the best visibility from the areas where the peripheral devices are used. Separate the transceivers as far as possible from each other while still providing the required coverage. You may mount the transceivers by using the metal hook or the rubber suction cups provided. An alternate method is to remove the metal hook and the rubber suction cups, replacing them with double-sided tape. The terminal transceivers must not be mounted on or next to metal objects.
4. Insert the male connector of the 12-foot cable from the terminal transceivers into the female connectors marked *Terminal Transceiver 1* or *Terminal Transceiver 2* on the terminal transceiver interface.

If the 12-foot cable is not long enough, it may be extended up to 1000 feet by using any four-conductor, one-to-one standard telephone extender cable available at various electronic appliance retail outlets.

You can also have the premises wired for extending the cables. Firms that install telephone cabling in buildings can perform this task because the wiring is identical to a two-circuit telephone system.



WARNING

To avoid damaging the terminal transceiver unit, do not insert the cable connectors from the single unit adapter or the terminal transceiver into any receptacle designated for use with the premises telephone system.

Large-Area Coverage

If the area to be serviced is too large for the extended basic coverage, configure the system for large-area coverage. (See Figure 4-3.) Add a power supply, Hypercom P/N 870003-001, to the terminal transceiver interface. The premises wiring may be expanded to support an additional eight terminal transceivers for a total of ten, maximizing the system for large areas or to fill in gaps in coverage.

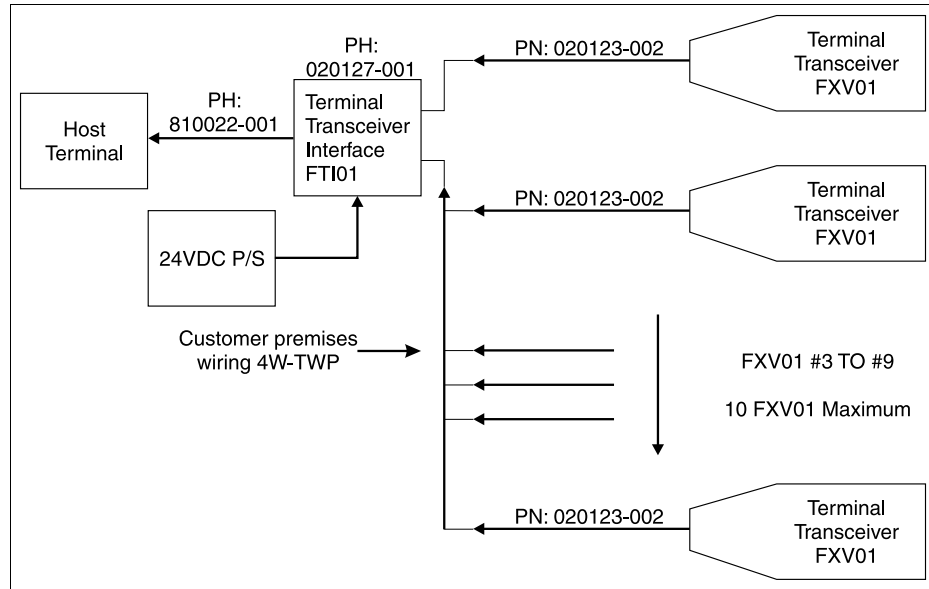

Figure 4-3. Large area coverage

Installing Large Area Coverage



Step-by-Step

To install large area coverage:

1. Ensure the host terminal is properly configured and connected for use as a standard POS terminal.
See the manual provided with the host POS terminal.
2. Insert one end of the PIN pad cable, Hypercom P/N 810022-001, into the PIN pad port of the host POS terminal. Insert the other end of the PIN pad cable into the connector marked *To Terminal* on the terminal transceiver interface, Hypercom P/N 020192-001.
3. Mount the terminal transceivers, Hypercom P/N 020123-002, to a vertical surface. Place them as high as possible in an area that has the best visibility from the areas where the peripheral terminal devices are used. Separate the transceivers as far as possible from each other while still providing the required coverage. You may mount the transceivers by using the metal hook or the rubber suction cups provided. An alternate method is to remove the metal hook and the rubber suction cups, replacing them with double-sided tape. The terminal transceivers must not be mounted on or next to metal objects.

4. Insert the 24-Volt power cable from the power supply, Hypercom P/N 870003-001, into the terminal transceiver interface receptacle marked *Power*. Insert the AC power cable from the power supply into an appropriate AC receptacle.
5. Insert the male connector of the 12-foot cable from the terminal transceivers into the female connectors marked *Terminal Transceiver 1* or *Terminal Transceiver 2* on the terminal transceiver interface.

If the 12-foot cable is not long enough, it may be extended up to 1000 feet by using any four conductor, one-to-one standard telephone extender cable available at various electronic appliance retail outlets.

You can also have the premises wired for extending the cables. Firms that install telephone cabling in buildings can perform this task because the wiring is identical to a two-circuit telephone system.

WARNING

To avoid damaging the terminal transceiver unit, do not insert the cable connectors from the single unit adapter or the terminal transceiver into any receptacle designated for use with the premises telephone system.

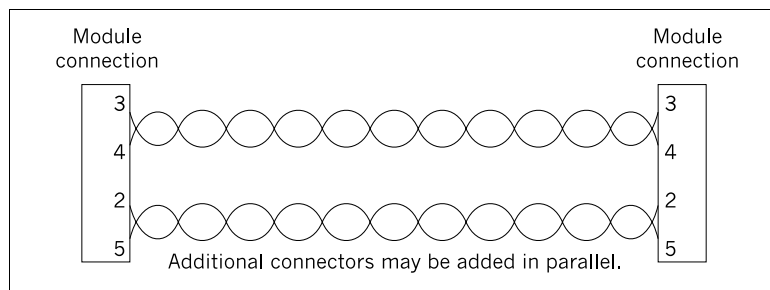

Figure 4-4. Premises wiring diagram

Installation Examples

Figures 4-5 through 4-7 are installation examples.

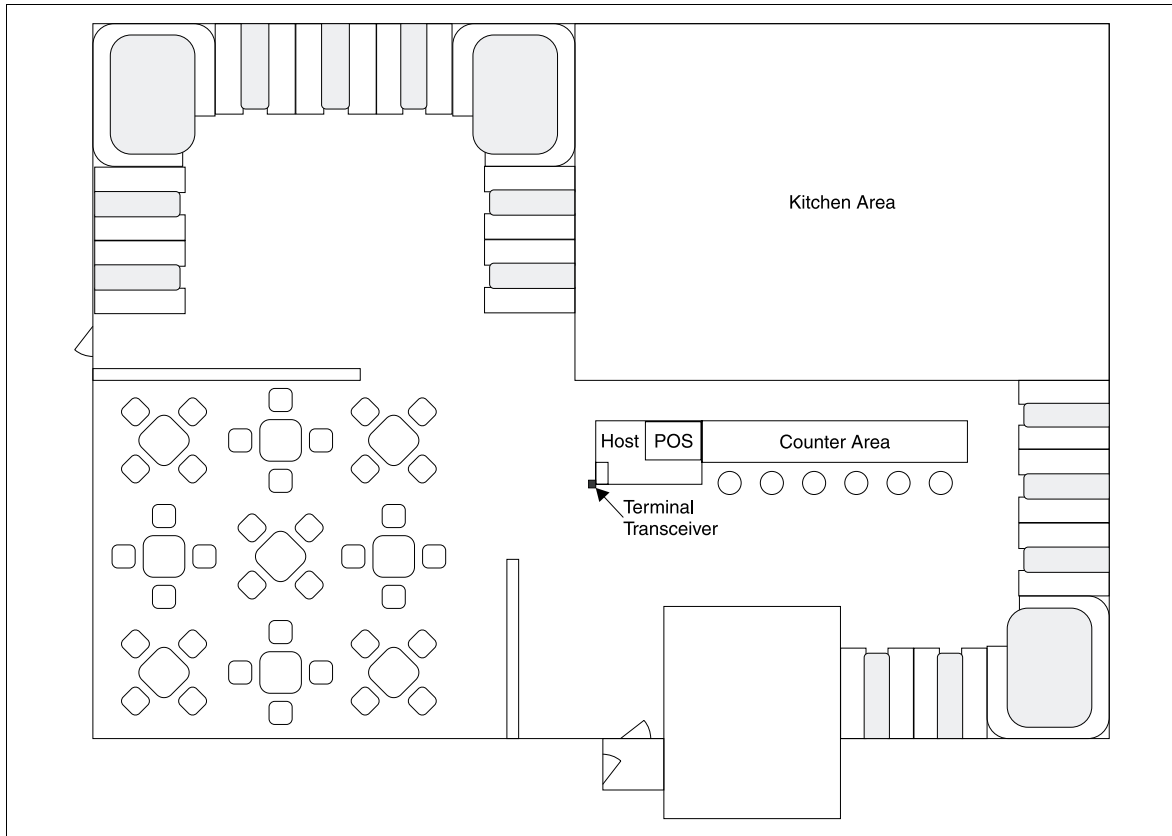

Figure 4-5. Basic system example

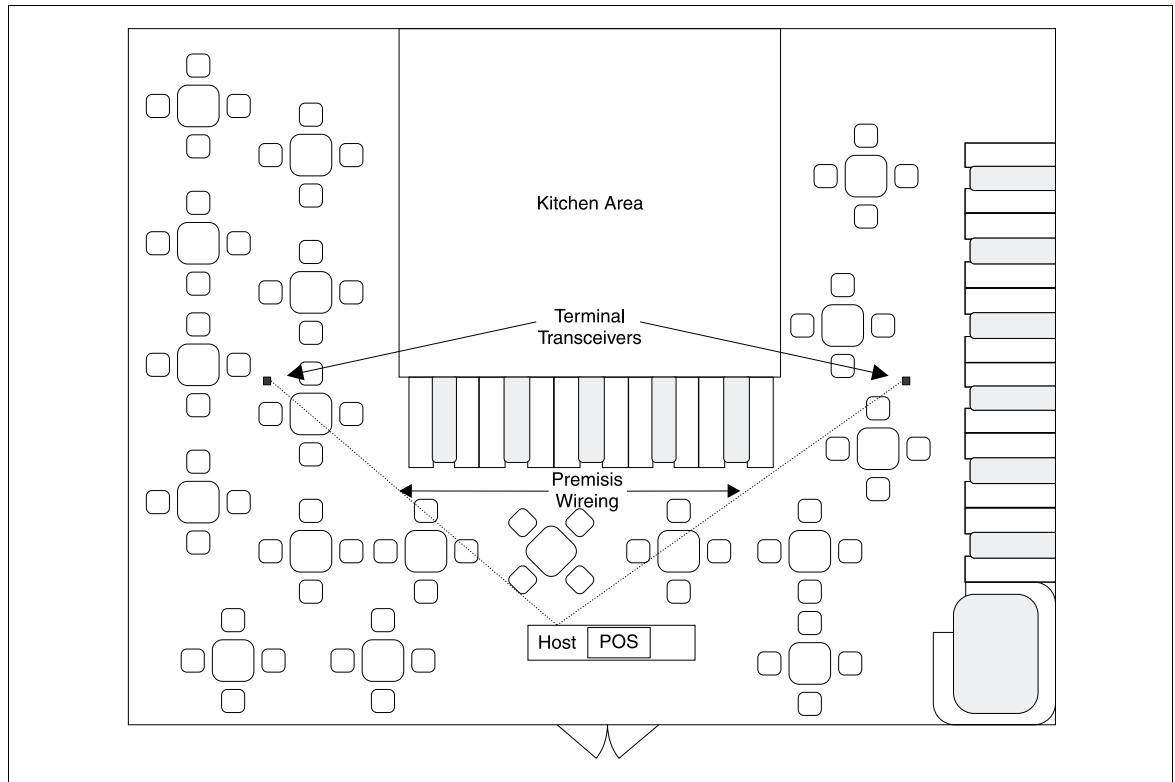

Figure 4-6. Extended basic example

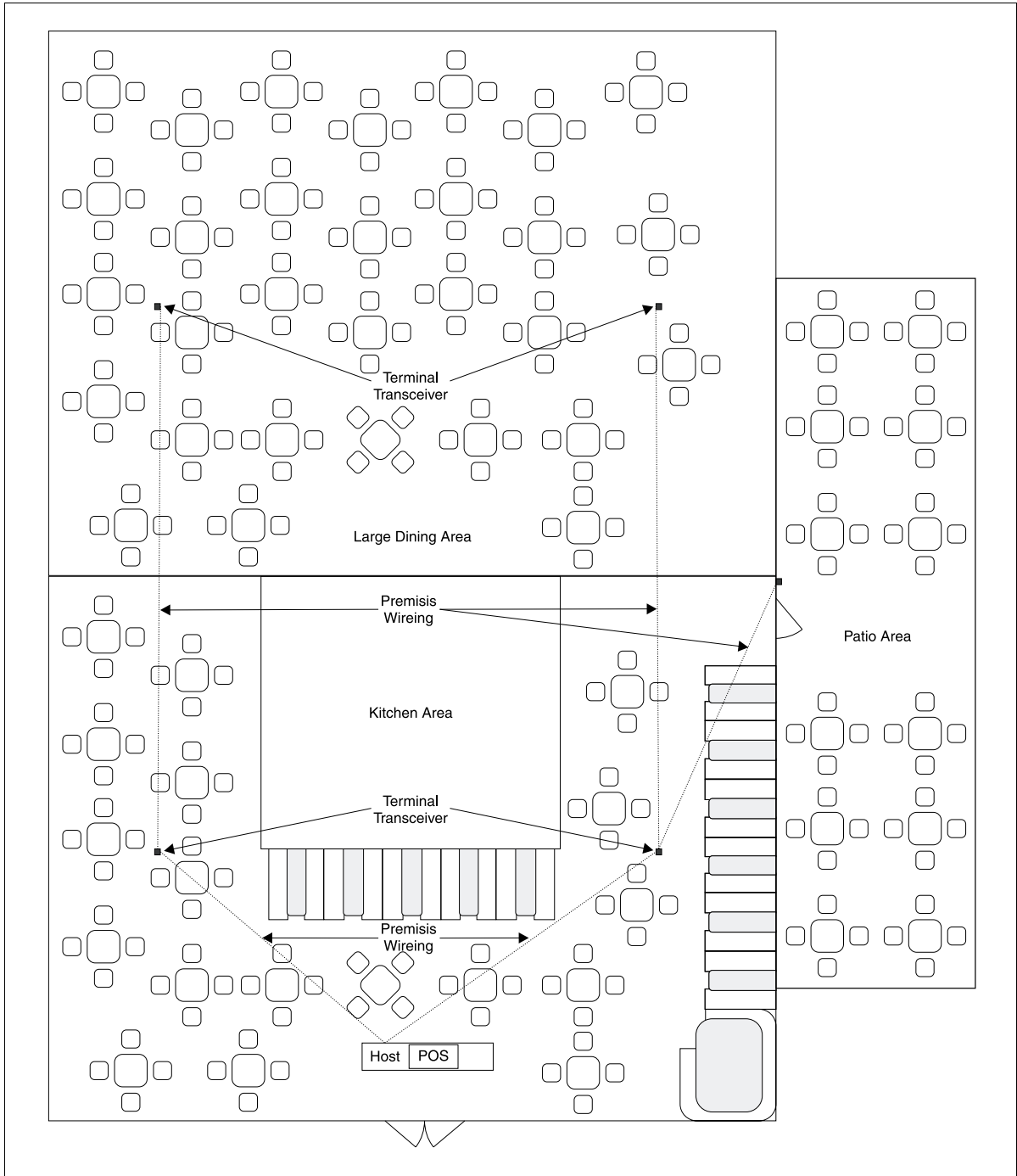

Figure 4-7. Large area example

Index

Numerics

24-Volt power cable 4-7

A

AC
 adaptor 2-1
 power cable 2-1, 4-7
 Adaptor cable 4-1
 Authorized Service 1-2
 auto receipt cutter 1-5

C

Caution xv
 messages xv
 Class A iv
 Class B 4-2
 commission decision 1-2
 conventionsxiv
 co-processor 1-3
 CTR21 iv

D

data encryption 4-1
 diagnosis 2-4
 dimensions 1-6

E

electrical Safety 1-2
 electromagnetic 1-2
 encryption key storage 1-3

F

FastPOS 1-5
 FCC Rules
 Class A iv
 Class B 4-2
 CTR21 iv
 Part 15 iv
 Part 68 iv
 FTI01 4-1
 function blocks 4-1

G

guide
 audiencexiii
 conventionsxiv
 organizationxiii

I

ICE 5700
 auto receipt cutter 1-5
 dimensions 1-6
 keyboard 1-3
 magnetic swipe card reader 1-4
 memory 1-5
 modem 1-5
 PIN pad 1-3
 power
 requirements 1-5
 security 1-3
 thermal printer 1-5
 touch-screen display 1-4
 initialization 3-4
 installation
 connecting the telephone line 2-3
 power up 2-1
 self-test and diagnostics 2-4
 interference 4-3

K

keyboard 1-3

L

load program 3-3

M

MAC software 3-3
 MAC-ing 1-3
 magnetic swipe card reader 1-4
 memory 1-5
 page 2-4
 message authentication 1-3
 modem 1-5

O

one-to-one standard phone cable 4-5

P

Part 15 4-2
 Part 68iv
 peripheral terminal device 4-1, 4-3
 PIN padxiii, 1-3
 cable 4-5
 encryption 1-3
 pixels 1-4
 power requirements 1-5
 PSTN 1-2

R

RAM 1-3
 receiver 4-2
 REN iv, v

S

SAM	
smart card	1-3
security	1-3
self-diagnostic	2-4
setup procedures	
ICE 5700	
loading printer paper	3-5
initialization	3-4
load program	3-3
wireless	4-3
short range	4-3

T

Terminal Transceiver	
FTI01	4-1
Interface	4-1
Term-Master	3-1
thermal printer	1-5
touch-screen	1-4
display	1-4

W

Warning	xv
messages	xv
Wireless POS Terminal interface	
function blocks	4-1
operations	4-2
instructions	4-2

We Welcome Your Comments

Please fax this page with your comments to Hypercom Corporation at 602.504.4990.

Document Number: 940310-001, rev A

- 1. In one word, how would you describe this guide? _____
- 2. How do you use this guide?
 - I read it from beginning to end.
 - I read only the sections that relate to my immediate needs.
 - I read only the sections that relate to my job.
- 3. Where do you usually look first to find information in this guide?
 - Table of contents
 - Index
 - Search through the pages until I find what I am looking for
- 4. How easily can you find information in this guide?

1 (Not easily)	2	3	4	5 (Very easily)
----------------	---	---	---	-----------------
- 5. How clear is the information in this guide?

1 (Not clear)	2	3	4	5 (Very clear)
---------------	---	---	---	----------------
- 6. How easily can you follow the instructions described in this guide?

1 (Not easily)	2	3	4	5 (Very easily)
----------------	---	---	---	-----------------
- 7. How well did you understand the product before reading this guide?

1 (Not well)	2	3	4	5 (Very well)
--------------	---	---	---	---------------
- 8. How well do you understand the product after reading this guide?

1 (Not well)	2	3	4	5 (Very well)
--------------	---	---	---	---------------
- 9. The best aspect of this guide is _____ .
- 10. The least useful aspect of this guide is _____ .

Additional comments:



Document Number 940310-001, rev A

Printed in the USA