

This file provided by

INFINITY

d a t a c o r p

Switch to Infinity Data Corp for your processing needs! Infinity offers great rates, excellent customer support and a wide range of payment processing solutions.

<http://www.infinitydata.com/>

Call Today!
Sales 1 800 393 6665



Unisys MyVision X Operator Manual

CONTENTS

0. Preface

1. General

- 1.1 Audience
- 1.2 Safety precautions
- 1.3 If the machine is damaged

2. Learning about the Unisys MyVision X

- 2.1 Packaging list
- 2.2 External parts description
- 2.3 Internal parts description

3. Operating your Unisys MyVision X

- 3.1 Document support installation
- 3.2 Power cables connection
- 3.3 USB2 cable connection
- 3.4 Ink jet cartridge installation
- 3.5 Pocket length adjustment

4. Getting started

- 4.1 Status lights**
- 4.2 How to prepare and load checks**
- 4.3 Clearing jams**

5. Maintenance

- 5.1 Cleaning the transport**
- 5.2 Cleaning the contact image sensors**
- 5.3 Cleaning the HP ink jet cartridge**
- 5.4 Cleaning photocells detector**
- 5.5 Replacing the feeder and separator rollers**
- 5.6 Cleaning the reading transport belt**
- 5.7 Install the external covers**

6. Specifications

- 6.1 Technical specifications for the Unisys MyVision X**
- 6.2 Technical specifications for the PC**
- 6.3 Consumable items for the Unisys MyVision X**

© 2004 Unisys Corporation. All rights reserved.

NO WARRANTIES OF ANY NATURE ARE EXTENDED BY THIS DOCUMENT. Any product or related information described herein is only furnished pursuant and subject to the terms and conditions of a duly executed agreement to purchase or lease equipment or to license software. The only warranties made by Unisys, if any, with respect to the products described in this document are set forth in such agreement. Unisys cannot accept any financial or other responsibility that may be the result of your use of the information in this document or software material, including direct, special, or consequential damages.

You should be very careful to ensure that the use of this information and/or software material complies with the laws, rules, and regulations of the jurisdictions with respect to which it is used.

The information contained herein is subject to change without notice. Revisions may be issued to advise of such changes and/or additions.

Notice to U.S. Government End Users: This is commercial computer software or hardware documentation developed at private expense. Use, reproduction, or disclosure by the Government is subject to the terms of Unisys standard commercial license for the products, and where applicable, the restricted/limited rights provisions of the contract data rights clauses. Correspondence regarding this publication can be e-mailed to doc@unisys.com.

The Unisys MyVision X is CE compliant and it has been tested in accordance with the requirements of the CEE directive N 89/336

The Unisys MyVision X is UL 950 compliant.



FCC Statement

The statement below is included in this document to comply with a Federal Communications Commission (FCC) regulation. The FCC is an agency of the United States government; thus, the statement below applies to computing equipment installed in the United States of America. Unisys is taking appropriate steps to be in compliance with FCC regulations and similar regulations of other countries.

WARNING: This equipment has been tested and found to comply with the limits for a Class A device, pursuant to Part 15 of FCC Rules. These limits are designed to provide reasonable protection against harmful interference when the equipment is operated in a commercial environment. This equipment generates, uses, and can radiate radio frequency energy and, if not installed and used in accordance with the instruction manual, may cause harmful interference to radio communications. Operation of this equipment in a residential area is likely to cause harmful interference, in which case the user will be required to correct the interference at his own expense.

Canadian Regulatory Statement

We certify the MVX, see page 19 of the Agreement, only for US FCC regulations. The Canadian Interference-Causing Equipment Regulation is not included.

Unisys is a registered trademark of Unisys Corporation in the United States and other countries. Panini, MyVision X, and MICR Plus are trademarks of Panini SpA. All other brands and products referenced in this document are acknowledged to be the trademarks or registered trademarks of their respective holders.

O. Preface

Here is an overview of the manual layout:

Chapter 1: “General” introduce you to all the general information regarding the manual or the Unisys MyVision X.

Chapter 2: “Learning about Unisys MyVision X” introduces you to all the major components of your machine.

Chapter 3: “Operating your Unisys MyVision X” describes simple installation procedures.

Chapter 4: “Getting started” explains how to operate the MyVision X.

Chapter 5: “Maintenance” describes how to solve problems that you may encounter using this machine.

Chapter 6: “Specifications” lists the main functions of the MyVision X and the features of the PC.

1. General

Congratulations on your selection of Unisys MyVision X!

The Unisys MyVision X is a new generation of check scanners. With a small footprint, sleek design and quiet operation, the Unisys MyVision X fits perfectly in a small area such as a teller window, or on the back counter of bank branches.

The Unisys MyVision X incorporates the latest, state-of-the-art technology and the latest standards for check processing in the marketplace.

A very unique, patent-pending 3-mode feeder can be found in the Unisys MyVision X, allowing for single item feeding, up to 30 items batch feeding with single hand insertion (in this case it is always possible to insert documents with one hand only) or up to 100 items batch insertion by manually moving the pressure plate.

MICR reading technology available with Unisys MyVision X is comparable to the larger and faster reader sorter, thanks to the newly released Panini MICR Plus™.

Taking advantage of the most up to date technology, the Unisys MyVision X connects to computers via USB2.0 interface, allowing for fast data transfer at no additional cost.

A rear ink jet endorser can also be found on the Unisys MyVision X.

The Unisys MyVision X has been designed specifically to allow for entire track accessibility, including scanner area (patent pending), for easy interventions and for maintenance purposes. This manual is written primarily for personnel who process checks or other documents.

1.1 Audience

1.2 Safety precautions

Before you begin operating or servicing your MyVision X as instructed in this manual, please make sure you read and understand these important safety instructions.

- Dress safely. Do not wear loose clothing, long hair or jewelry that can become entangled in moving parts.
- Do not allow anything to rest on the power cord or position the MyVision X where the cord may be stepped upon.
- Always unplug the MyVision X before cleaning.
- Do not attempt to service or repair the MyVision X, except as instructed elsewhere in this manual.
- Attempting to service or repair the external power supply of the MyVision X may expose you to dangerous voltage points or other risks.
- Refer all servicing to qualified service personnel.

1.3 If the machine is damaged

Unplug the MyVision X from the wall outlet and refer servicing to qualified personnel under the following conditions:

- If the power cord is damaged or frayed.
- If liquid has been spilled into the product.
- If the equipment has been exposed to rain or water.
- If the equipment does not operate normally when the operating instructions are followed.
- If the equipment has been dropped or damaged.
- If the equipment exhibits a distinct change in performance, indicating a need for service.

Adjust only those controls and replace only those items that are covered by the instructions in this manual.

If you attempt to make adjustments not covered in this manual, you may damage the equipment and void the warranty.

Unauthorized adjustments or repairs may result in the need for extensive work by a qualified technician to return the equipment to its proper working condition.

2. Learning about the Unisys MyVision X

The Unisys MyVision X is a compact, easy-to-use and quiet scanner.

The Unisys MyVision X automatically scans the front and/or rear of checks while simultaneously capturing the Magnetic Ink Character Recognition (MICR) code line. It is also provided with an ink-jet endorser which can print alphanumeric characters on the back side of checks. Any of the Windows standard fonts can be selected and utilized while printing. The Unisys MyVision X is connected to a PC via USB2.0 interface.

2.1 Packaging list

The Unisys MyVision X package includes:

1. Unisys MyVision X Scanner Unit
2. Operator Manual
3. Feeder Extension
4. Ink-Jet Cartridge
5. USB 2 Cable
6. Power Cable
7. Power Supply
8. #1 Feeder Ring, #1 Front Separator Ring, #1 Rear Separator Ring

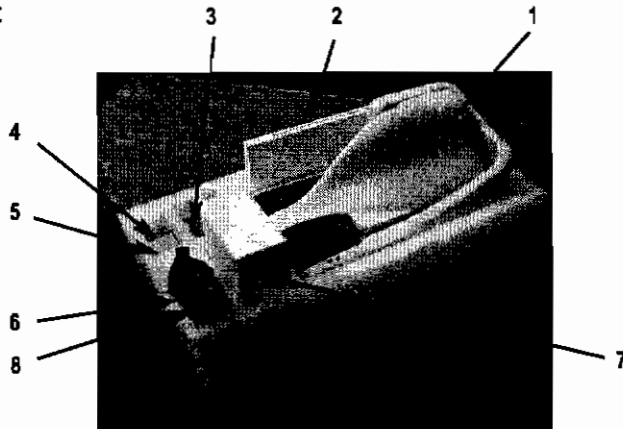

Important: To preserve the feeder area against shipping shocks, a blue block of polystyrene has been placed between the feeder roller and the pressure plate. Please take care to remove it before installing the MyVision X and always use it when you are going to ship again.

Block of
polystyrene

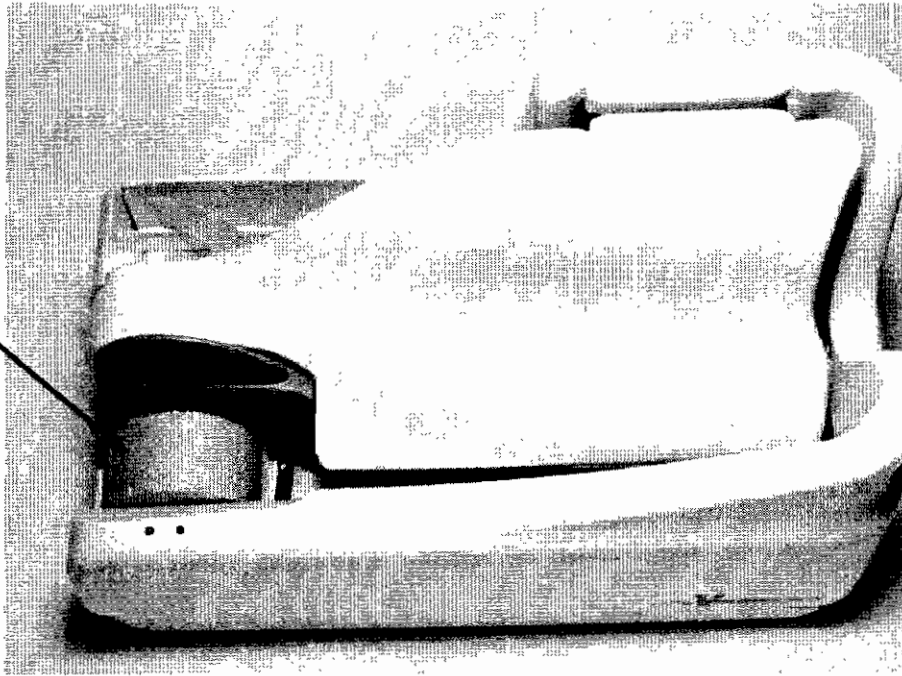

2.2 External parts description

This section describes the major components of the Unisys MyVision X. The component names shown in these figures are used throughout this manual.

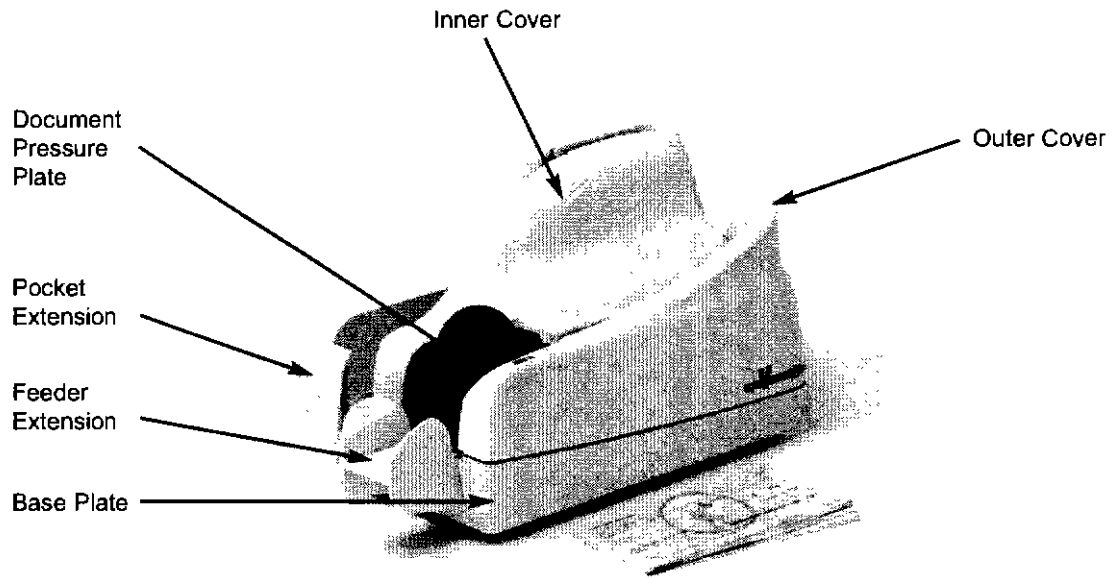

2.3 Internal parts description

1. Document Pressure Plate
2. LED & Interlock Board
3. Feeder Roller
4. Feeder Sensor
5. Separator Roller
6. Rear Separator Roller
7. Pre-magnetization Head
8. Synchronization Sensor
9. MICR Reading Head
10. "U" Track Wall
11. Transport Rollers
12. Ink Jet Cartridge
13. Front Image Camera
14. Rear Image Camera
15. Pocket Sensor
16. Transport Belt
17. Interlock Board
18. Feeder Motor

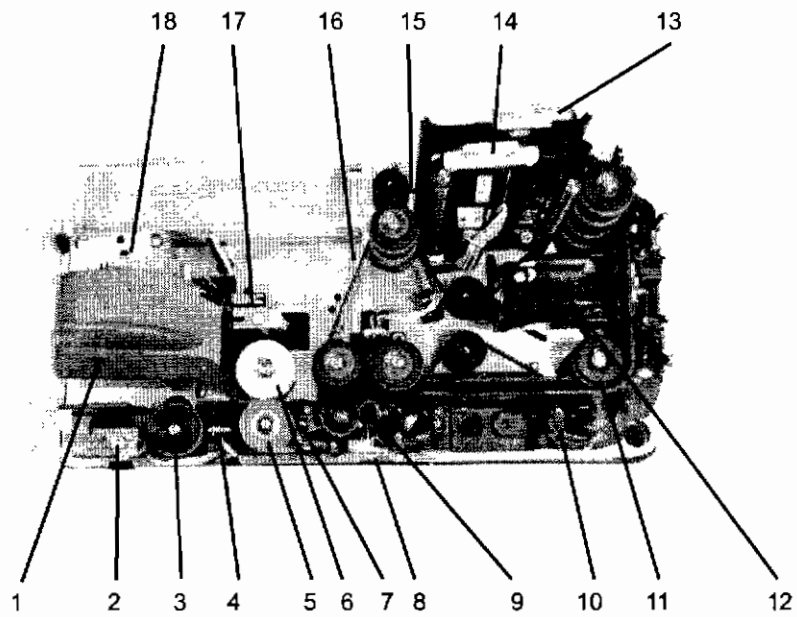

3. Operating your Unisys MyVision X

3.1 Document support installation

Insert the Feeder Extension in the slot uncovered by pushing backward the Document Pressure Plate. Installation is correct if the Feeder Extension is at the same level of the entrance of the scanner platform.

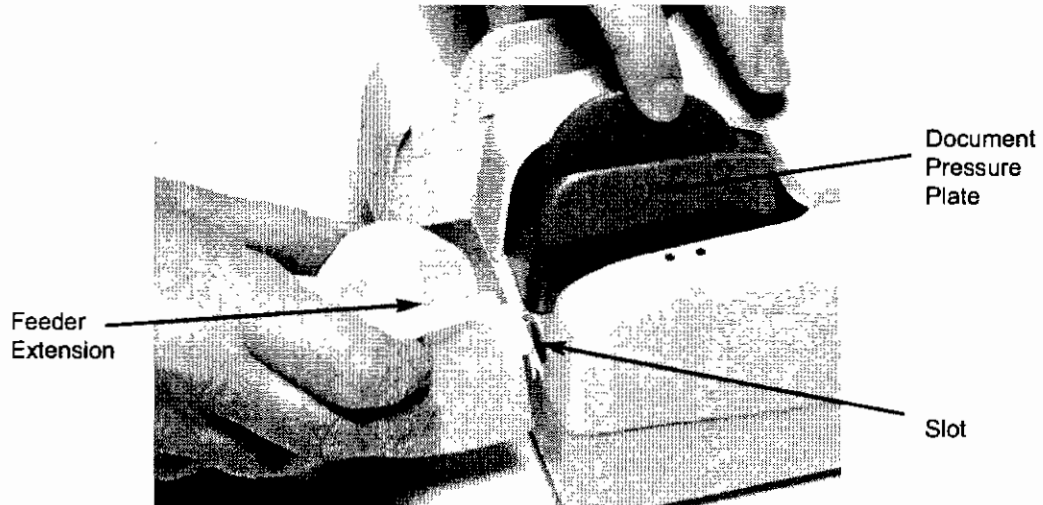

3.2 Power cables connection

Before connecting the scanner to your PC, make sure to locate the unit on a flat surface near the PC, away from direct light and from electromagnetic equipment.

Warning: The electromagnetic emission from a CRT monitor can produce interference and affect the MICR reading. Place the MyVision X as far as possible from the CRT.

1. Plug the power cord connector in the Power Supply socket. See Fig.1.
2. Plug the Power Supply cable in the MyVision X power connector. See Fig.2.

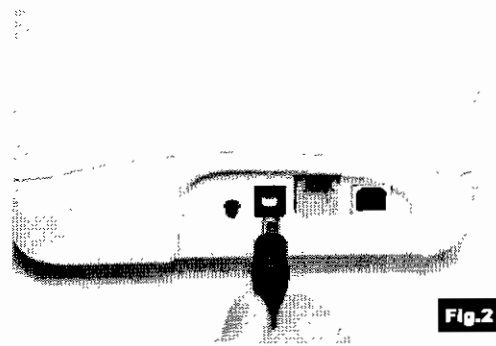
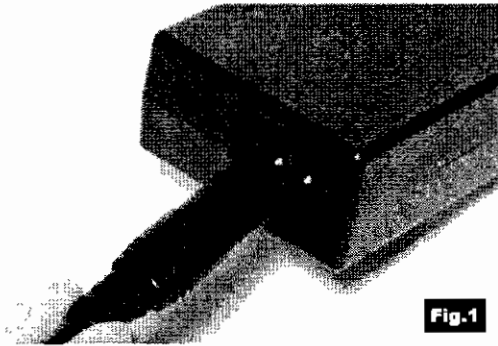

3. The MyVision X should be plugged into a dedicated electrical power outlet. The power supply will be 100-240 VAC (no power selection required), and the frequency 50/60 Hz. If you are not sure of the type of power available, consult your Service Representative or local power company.

3.3 USB2 cable connection

Connect the USB 2 cable to the USB 2.0 port located on the rear side of the scanner and the other side of the cable to an available USB 2.0 port on the PC.

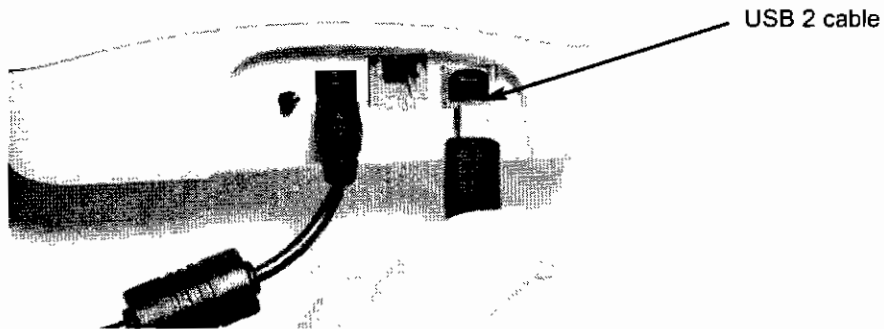

3.4 Ink jet cartridge installation

Remove the inner cover.

Take a new ink jet cartridge out from its package.

Do not touch the ink with your fingers or clothing; it will stain. Read and follow the instructions in the HP cartridge box for proper cartridge preparation.

Angle the front side of the cartridge downward and face the two pins with the two holes in the cradle.

Gently push down the rear side of the cartridge until it snaps in the plastic retainer.

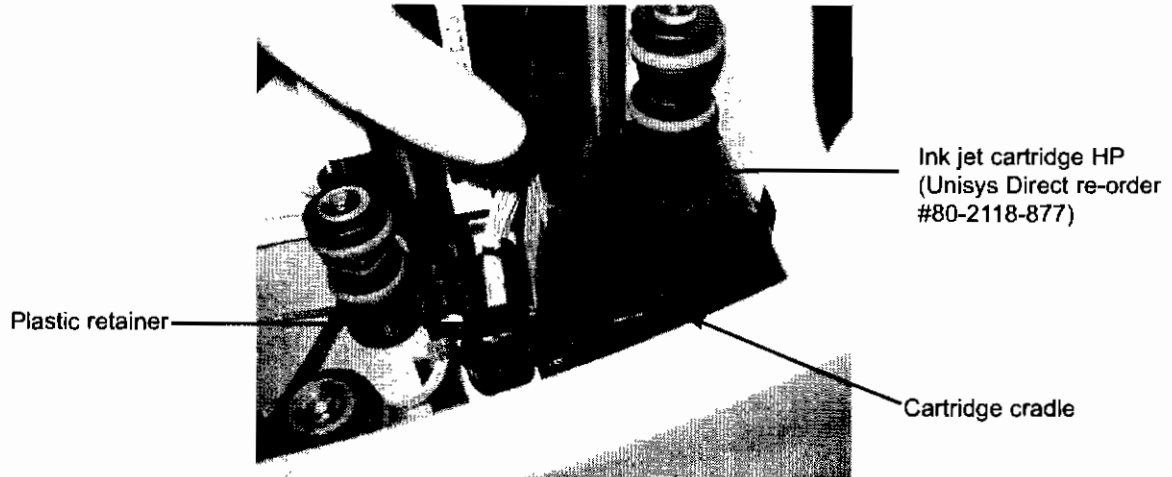

3.5 Pocket length adjustment

Adjust the pocket length by inserting the longest document that will be processed in the pocket. Move the pocket extension left or right until a space of 5 mm (1/4 in.) is available between the leading edge of the document and the end of the pocket extension.

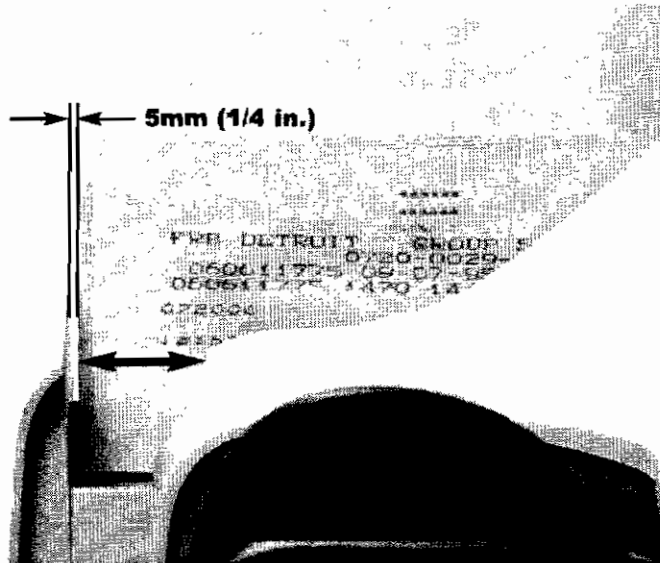

4. Getting Started

1. Turn on the PC.
2. Start the application program (see note).
3. Follow the application program instructions.
4. Load your checks.

Note: Determine what application program will be running during your document processing session. An application must be started before you begin to process documents. If it is your job to start the application, refer to the documentation supplied with the application by the vendor.

Normally, the MyVision X goes automatically online when the control application starts, and goes offline when the control application shuts down. If you want to force the reader to go offline even when the application is on, press the rear switch button for at least one second. At this point, the motor will briefly buzz and the green LED will turn off. To return the reader online (only if the using application is still running), press the switch button again for at least one second. The motors will briefly buzz and the green LED will turn on. This operation is allowed only when the MyVision X is idle, and will be ignored if the reader is working. Acting on the switch button when the green LED is off will have no effect.

4.1 Status Lights

Two status light located near the feeder indicate the status of the unit.

The following table describes the meaning of each status light.

Red LED	Green LED	Description
Off	Off	The MyVision X is offline
Off	On	The MyVision X is online and the feeder is empty
Off	Blinking	The MyVision X is online and the feeder contains one or more documents ready to feed
On	Off	Interlock switches are activated and an external plastic cover is removed
Blinking	Off	Jam in the transport track

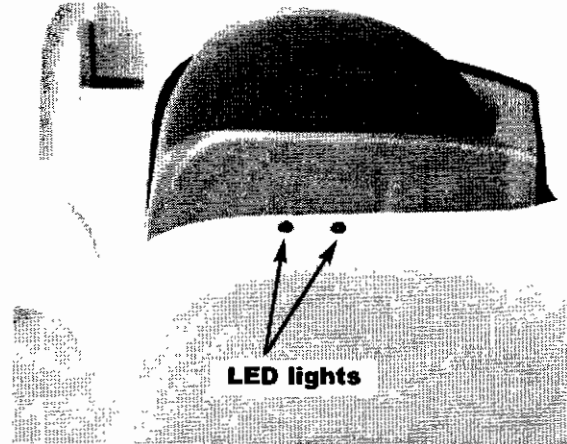

4.2 How to prepare and load checks

Preparing Documents for Processing

1. Remove all rubber bands, staples, paper clips, dog ears, etc. from the documents.
2. **Jogging the documents is strongly recommended.**
Align the bottom edges by repeatedly tapping the bottom edge of the documents on a hard, flat surface. See Fig.1.
3. Repeatedly tap the leading edge of the documents on a hard, flat surface. See Fig.2.
4. Check bottom and leading edges once more to ensure documents are aligned.

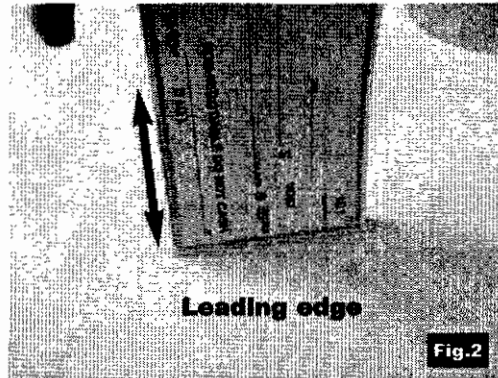
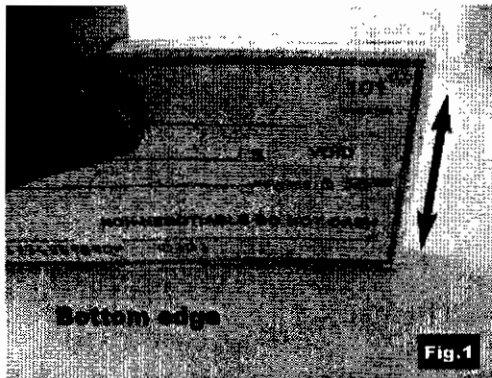

Feeding documents

You may feed documents one at a time or in batches of up to 30 by inserting the documents into the feeder all the way. See Fig.3. The documents must be inserted into the feeder so that the **leading edge** fits between the two white lines. See Fig.4.

Note: With the 30 document feeder option, if more than 30 documents are placed in the feeder, feeding will stop after 30 consecutive documents are fed. The remaining documents must be removed and reinserted into the feeder to continue. This action is not necessary if the feeder empties before 30 documents are fed.

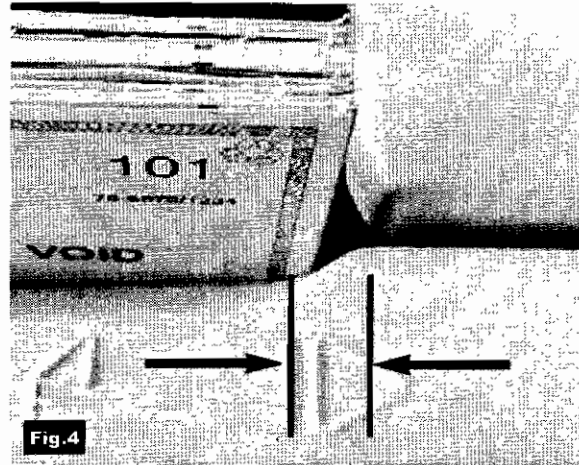
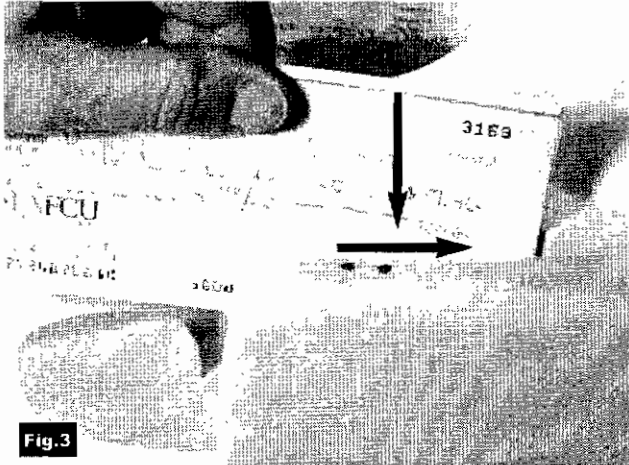

Batches greater than 30 to 100 checks, requires the pressure plate to be pushed back before inserting checks into the feeder.

To prevent misfeeding, do not insert more than 100 documents into the feeder. Leave at least 2 mm (1/8 in.) between the last document and the pressure plate in the maximum backwards position. The leading edges of the documents should be aligned as described in the previous page.

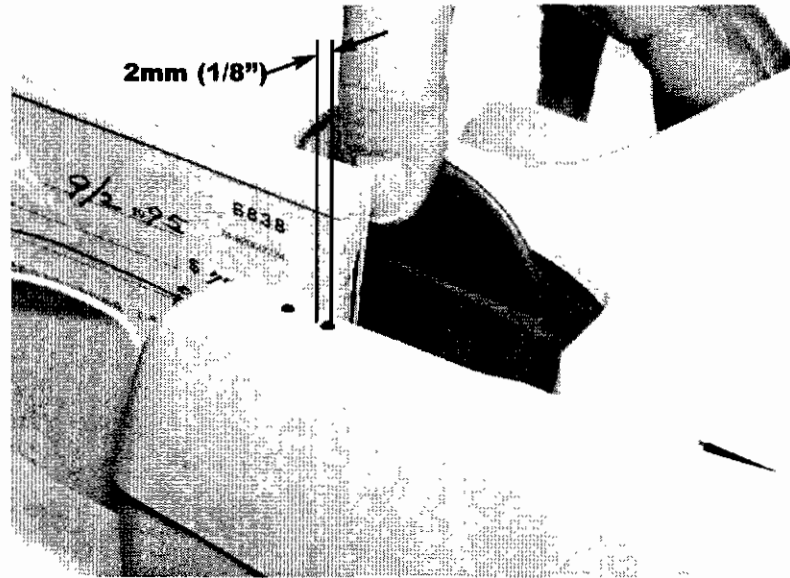

The feeder is designed so that checks can be loaded continuously, while the scanner is processing. This can be done by inserting checks behind those already present in the feeder.

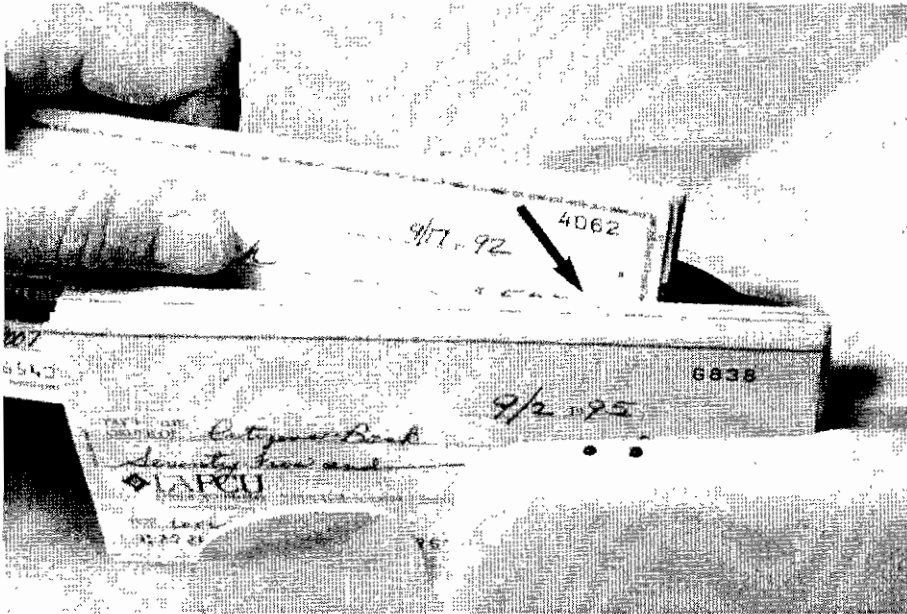

Removing documents from pocket.

Processed documents are sent to the exit pocket.

For best results, follow these recommendations:

- Remove the documents when the pocket is nearly full. Jams occur when the pocket is too full. (No pocket full sensor is available.)
- Occasionally verify that the endorsements are clearly printed.
- Occasionally verify that the images are being properly captured and that the quality is of good condition.

4.3 Clearing jams

When a jam occurs, the paper path must be cleared. To do this, first remove all the documents from the exit pocket and then free the track pressing eject in your application. In case of unsuccessful operation, apply the following suggestions:

Extract the jammed document simply by pulling it out with your fingers. See Fig.5.

If this is not successful, lift the inner cover at the point indicated by the stripped surface. See Fig.6.

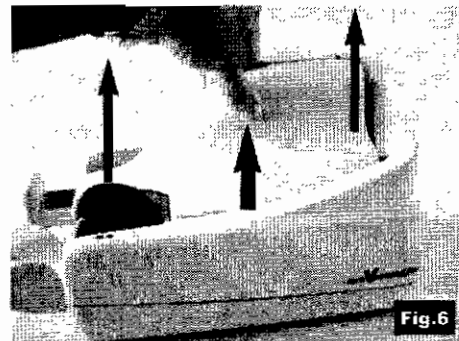

Grab the document with your fingers and remove it from the transport. See Fig.7.

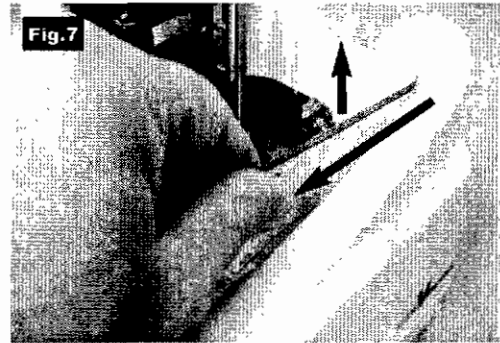

After the jam is removed, install the inner cover by following the instructions below:

1. Insert the two reference **shafts** in the corresponding **housings** found in the inner cover. See Fig.8.

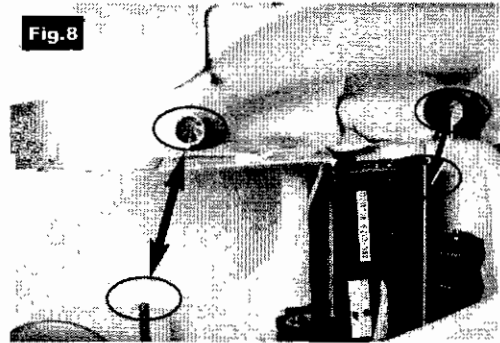

2. Push down the inner cover until it is back to its original position. Take care to ensure that the inner cover stays behind the scanner (black). See Fig.9.

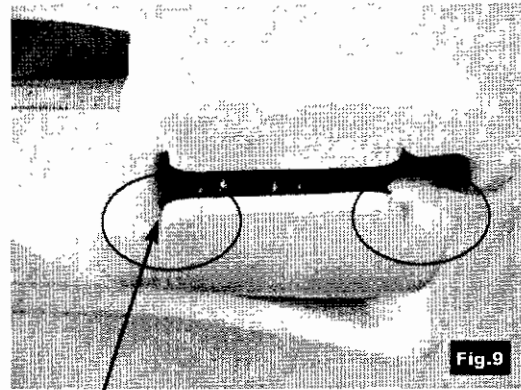

The inner cover (grid) must be inserted behind the scanner (black)

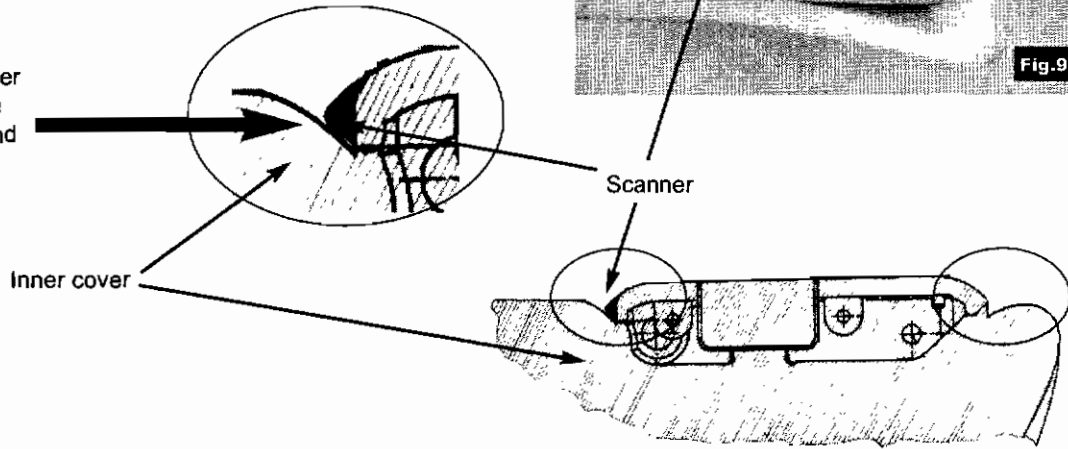

3. Check the exit pocket to ensure that the two plastic springs are aligned properly. See Fig.10.

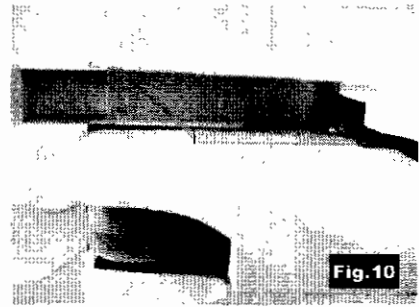

In the event that the outer cover has to be removed, lift it off. See Fig.11.

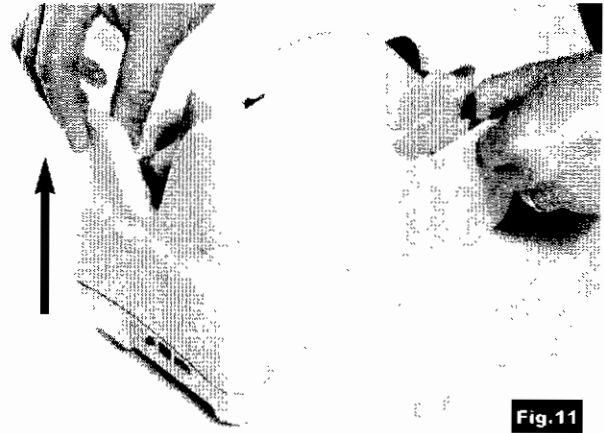

4. To remove the "U" track wall see Fig.12.
Please follow the instructions in chapter 5.1.2.

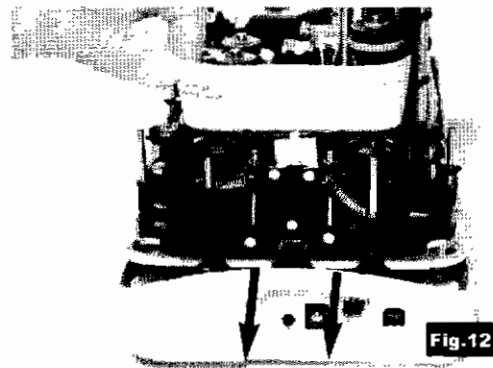

5. If the jam occurs in the image camera area,
it is advisable to open the front image camera
(see Fig.13) so that the document can easily be
removed.
6. **Close the image camera carefully.**
Do not allow the spring to snap it closed.

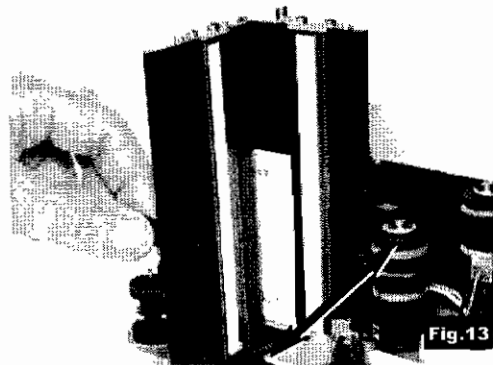

7. Insert the outer cover by aligning the two shafts with the holes in the base of the unit. See Fig.14.

8. Insert the two teeth located on each side of the outer cover, in the base and lock it. See Fig.15 and 16.

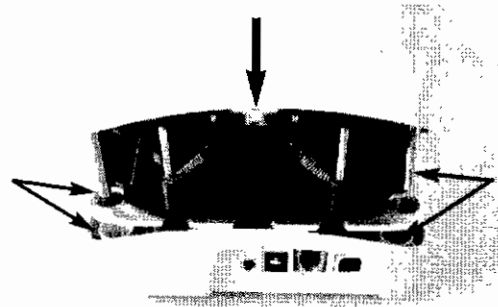

Fig.14

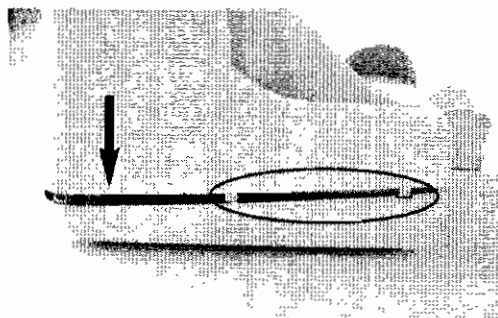

Fig.15

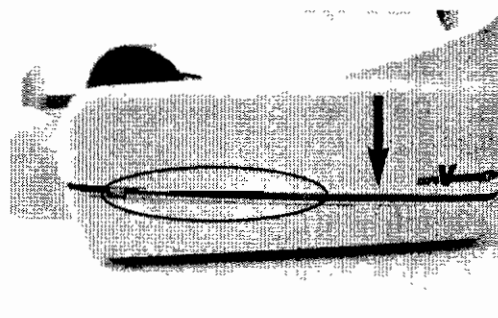
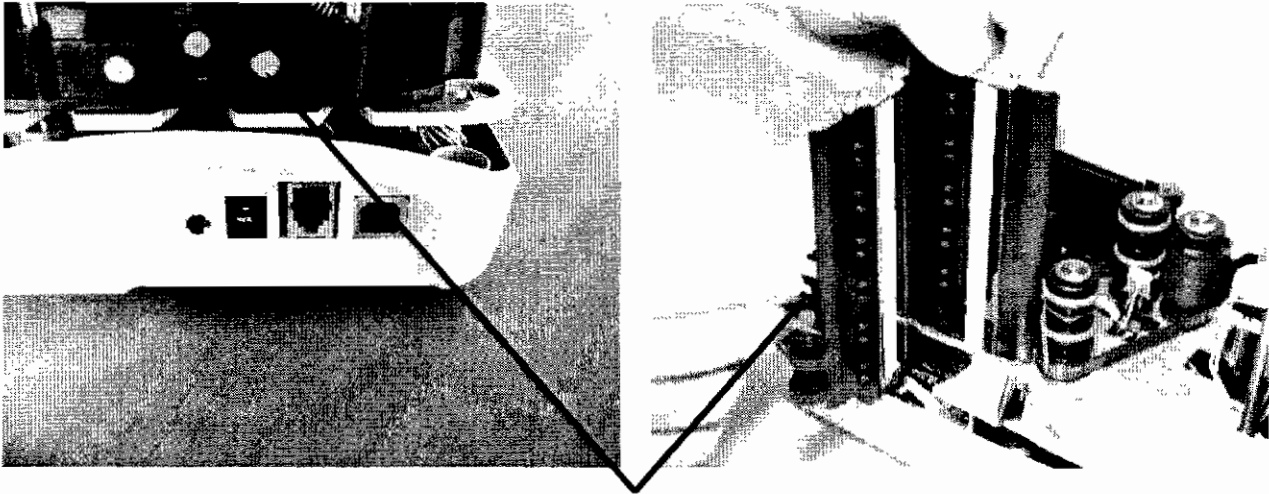

Fig.16

5. Maintenance

Warning: Before doing maintenance, remember to disconnect the USB2 and power cables from the device.

Note: The parts accessible to the operator for cleaning or jam removal are identifiable by green stickers.



Green stickers

5.1 Cleaning the transport

Dust, lint, and small particles can get into the track area. Clean this area as follows:

1. Remove the inner and outer covers by pulling up on the covers as illustrated below.

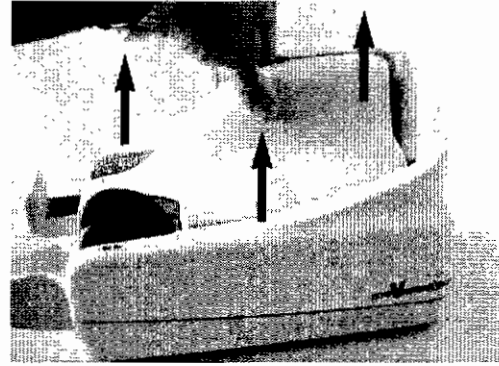
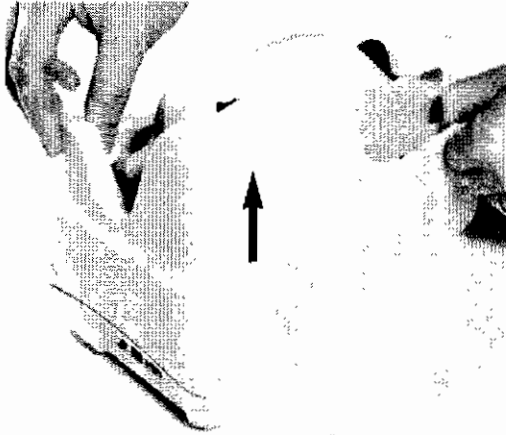

2. To remove the U-track, pull back on lever. See Fig.17 (1).

Fig.18 shows how to pull the lever and remove the U-track.

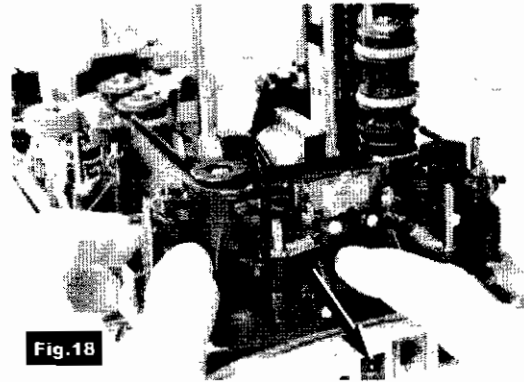
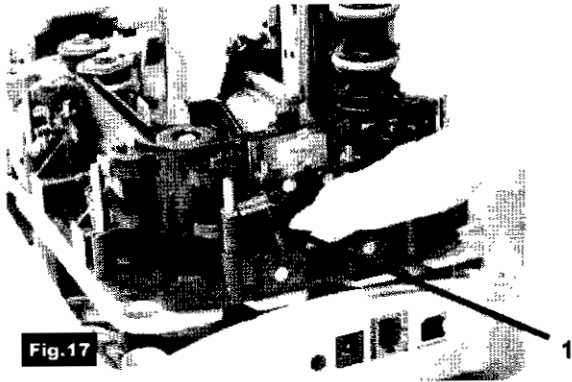

3. Inspect and clean the entire track area from beginning to end.
4. Remove staples, paper clips, rubber bands, and pieces of paper that may have accumulated during use.
5. Using a container of canned air with nozzle, spray the track area and check entrance.

6. To reinstall the U-track, insert the two teeth "C" in the rail "D". See Fig. 22.
Align the U-track. See Fig.19. Push back the U-track, as shown in Fig.22, until the lever "E", see Fig.19, locks the unit in place. Make sure that the pin "B", as shown in Fig.23, is inserted in the receptacle "A", see Fig.20.

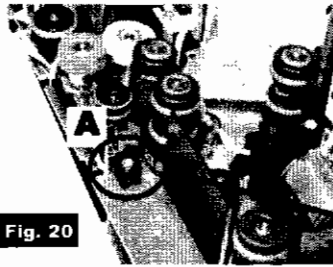

Fig. 20

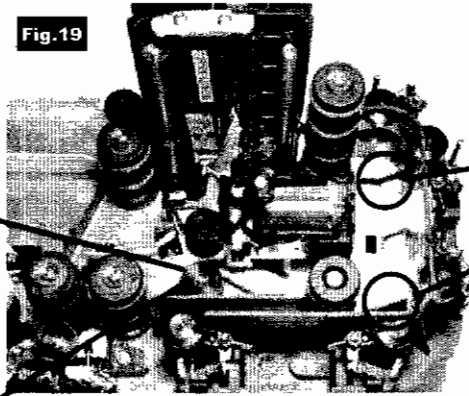

Fig. 19

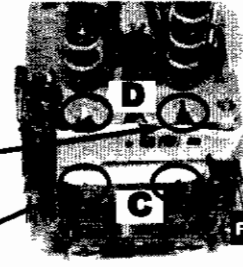
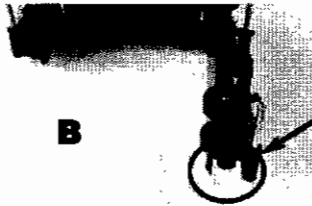

Fig. 22



B

Fig. 21



Fig. 23

5.2 Cleaning the Contact Image Sensors

1. Gently open the front image camera, see Fig.24, and remove any debris and dust.
2. Clean the contact image sensors with a soft, lint-free cloth dampened with isopropyl alcohol or with eye glass cleaner. See Fig.25.

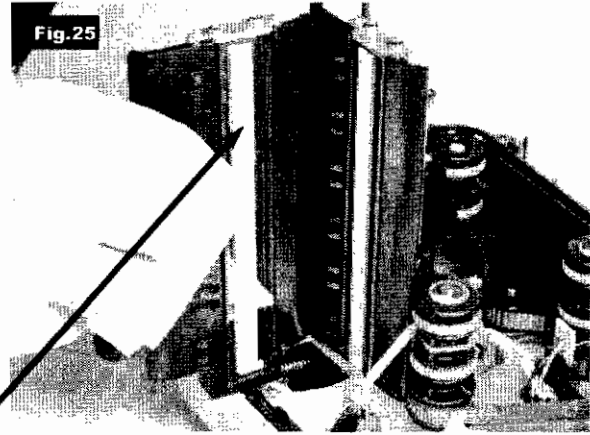
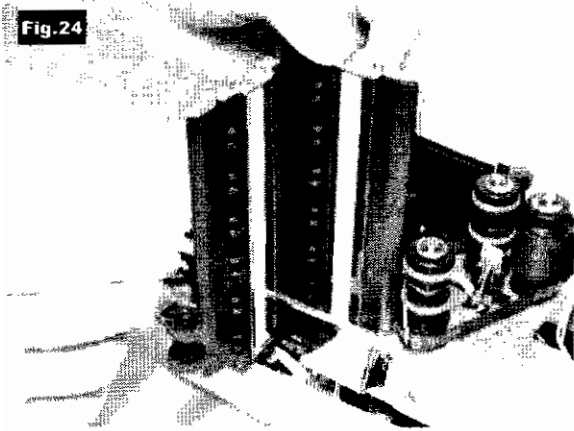

**Contact Image Sensor
(CIS)**

5.3 Cleaning the ink jet cartridge

Fibers, such as cotton or paper, dried ink plugs or crust, or excess ink puddles on the nozzle plate can obstruct ink droplets or cause ink droplets to deflect from the desired trajectory, resulting in a degraded print quality.

When this occurs, remove the print cartridge by pushing down the plastic retainer. See Fig.26.

Wipe the cartridge with a wet lint-free cloth. See Fig.27. De-ionized water is recommended.

Wipe slowly across the long axis with the print cartridge facing down. Do not apply excessive force, as this could scratch the nozzle area.



Remove the ink jet cartridge when transporting the unit and when the unit is not used for long periods

In case the scanner is not used regularly, periodically clean the ink jet nozzles with a lint-free cloth.



Plastic retainer

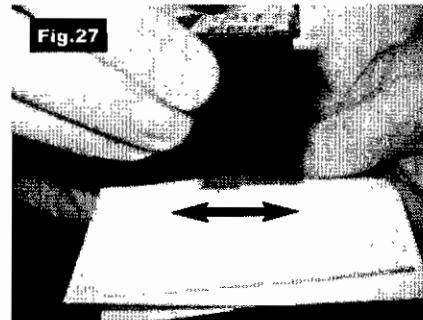

5.4 Cleaning photocells detector

The six photocells (emitter and receiver) are identified with white circles, see Fig.28 below. Using a container of canned air and nozzle, spray the sensors to remove any dust. See Fig.29. Also a dry soft cloth can be used. (Care must be taken not to alter the position of the sensors.)

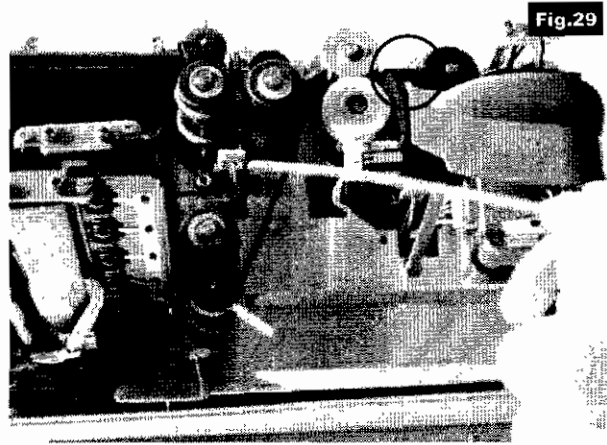
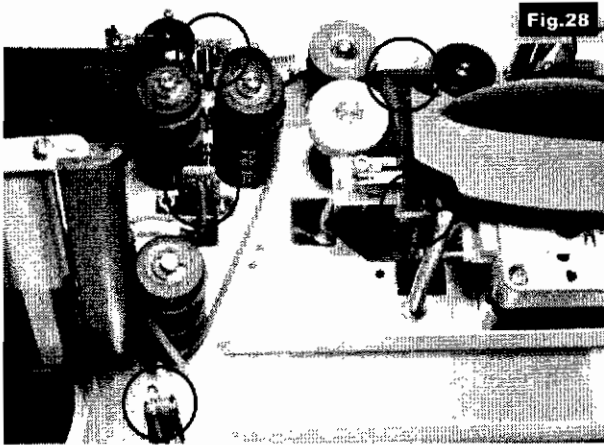

5.5 Replacing the feeder and separator rollers

After extended use it will be necessary to replace the feeder and separator roller rings due to normal wear.

1. Open the inner and outer covers.
2. Carefully lift the rings off the rollers. (See arrows in Fig. 30, 31, 32)

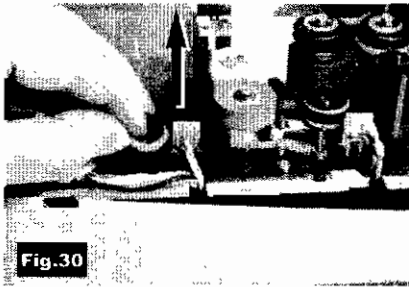

Feeder ring

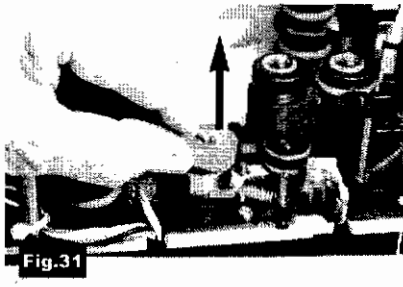

Front separator ring

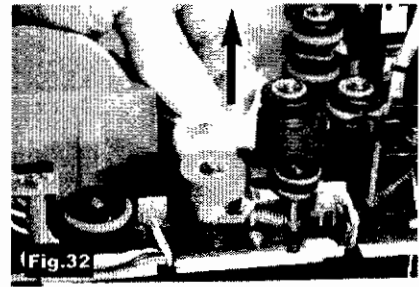

Rear separator ring

3. Install the new separator rings on the hubs by pressing down on the surface of the rings, making sure the rings are installed flat on their seats. The feeder ring must be rolled onto the black pulley.

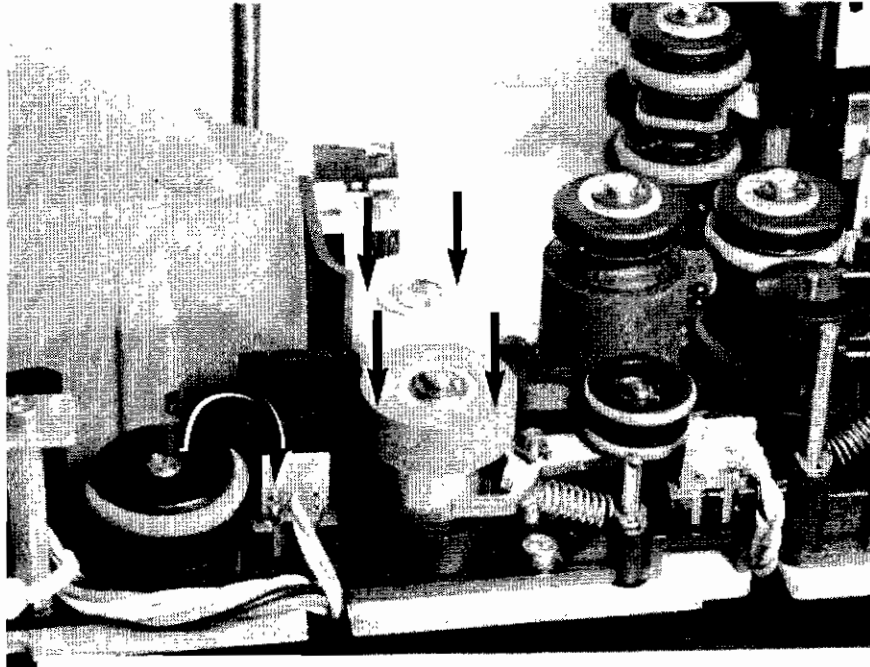

5.6 Cleaning the reading transport belt

If an increase in the number of MICR (Magnetic Ink Characters Recognition) rejects is noticed, it may be necessary to clean the surface of the reading transport belt to remove extraneous magnetic ink or iron dust.

Clean the external surface of the belt with a soft, lint-free cloth, dampened with isopropyl alcohol. Turn pulley "A" counterclockwise to move the belt in the direction of the arrow and clean the entire belt surface.

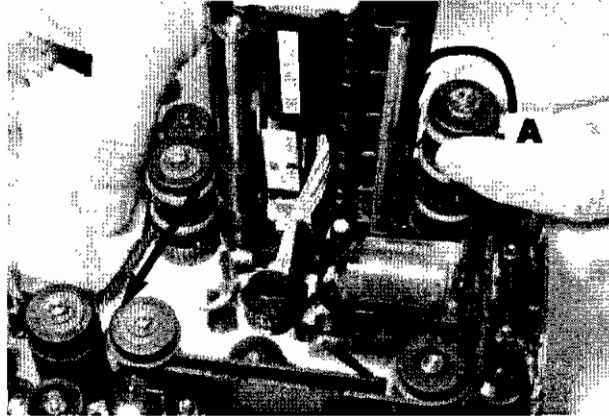

5.7 Install the external covers

Install the inner cover following the instructions below:

1. Insert the two reference **shafts** in the corresponding **housings** found in the inner cover. See Fig.33.
2. Push down on the inner cover until it stops, be careful that the inner cover stays behind the scanner (black). See Fig.34.

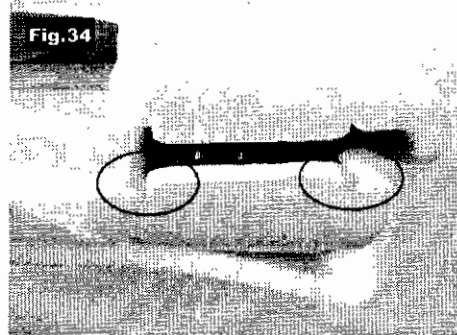
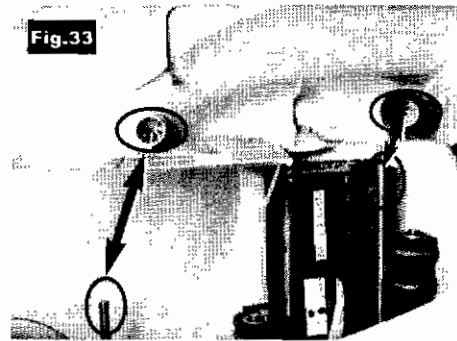

The inner cover
(grid) must be
inserted behind
the scanner
(black)

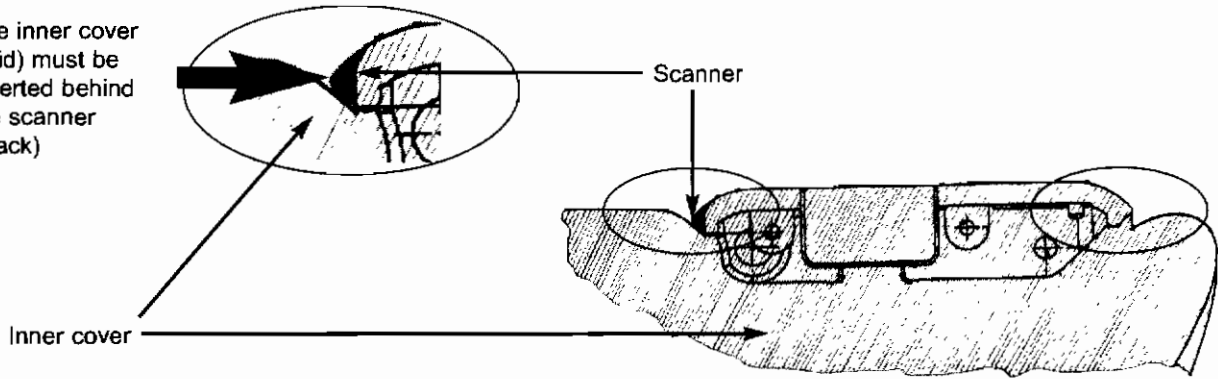

3. Check the exit pocket to ensure that the two plastic springs are properly aligned as shown in Fig.35.

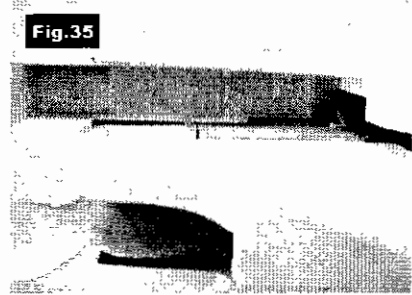

4. Insert the outer cover by aligning the two shafts with the two holes in the base of the unit. See Fig.36. Push down the cover.

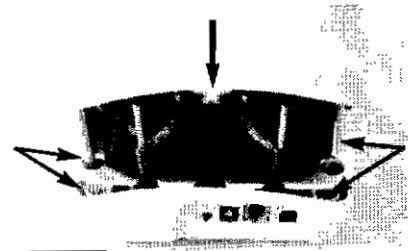

Fig.36

5. Insert the two teeth located on each side of the outer cover, in the base and lock it. See Fig.37 and 28.

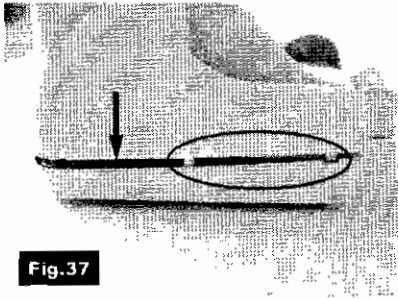

Fig.37

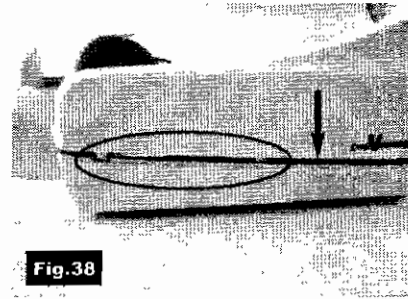

Fig.38

6. Specifications

6.1 Technical specifications for the Unisys MyVision X

Performance	Various models processing up to 30 dpm, 60 dpm or 90 dpm with a USB 2.0 interface.
Automatic Document Feeder	3 mode feeder: <ul style="list-style-type: none">- Single document automatic insertion- Holding up to 30 documents for automatic batch one hand insertion- Holding up to 100 documents, with pressure plate Double feed detection. Auto-tuning separator rollers designed to process varied thickness of documents and compensate wear.
Pocket	A single exit pocket capable of holding up to 100 documents.
Document Specifications	Height: Min: 54 mm (2.12") - Max: 106 mm (4.17") Length: Min: 80 mm (3.14") - Max: 235 mm (9.25") Weight: Min: 60 gr/m ² (16 lb) - Max: 120 gr/m ² (32 lb)
Interface	USB2.0 port/backward compatible with USB1.1. RS232 port for external device connection. (SW/FW developments on request)
Magnetic Reader	E13B /CMC7/Autorecognition Panini MICR Plus™ exclusive technology
Image Capture	Scanning: Contact image sensors (CIS) technology (front and back) Image format: Bitmap in B/W, 256 shades of gray, TIFF, JPEG, and Group IV compression Image resolution: 100 or 200 dpi Advanced dynamic thresholding Dual Image: 4 images in one document pass

Software Tools	Panini Vision API running on: Windows 2000 SP 3 and XP SP 1with USB2.0 or USB1.1 at reduced performance.			
Optional Software Tools	Optional: ICR Vision function for image snippet definition & download. Integration of Barcode, OCR recognition technology.			
Ink-Jet Printer	Rear ink jet printer. Printing capability: Single line, Alphanumeric characters, all MS Windows fonts. Printed information captured by the image.			
OCR Recognition (optional)	OCR-A, OCR-B, E13B recognition engine			
Barcode Recognition (optional)	CODE 39, CODE 128, INTERLEAVED 2/5, EAN8, EAN13, UPCA, UPCE			
Diagnostic Features	On board Diagnostics: Tests the functionality of the scanner. Power-on Self Testing: Automatic self testing and photocells calibration when powering the unit.			
Maintenance	Maximum accessibility to every component to minimize MTTR. Total access to scanner and track area. Firmware upgradable via PC.			
Input Voltage	Autosensing from 100 to 240 VAC. 47 to 63 Hz.			
Dimensions	Height 175 mm (6.88 in.)	Width 138 mm (5.43 in.)	Length 264 mm (10.39 in.)	Weight 2.5 Kg (5.51 lb)

Specifications subject to change without previous notice.

6.2 Technical specification for the PC

Panini Vision API running on: Windows 2000 S.P.3 and Windows XP S.P.1 with USB2.0 or USB1.1 port	
30 dpm and 60 dpm Models	
Recommended	Minimum
1GHz Pentium IV processor	500 MHz Pentium III processor
256 MB RAM	128 MB RAM
200 MB free disk space	200 MB free disk space
USB2.0 port	USB2.0 port
90 dpm Models	
	1.2 GHz Pentium III processor
	256 MB RAM
	200 MB free disk space
	USB2.0 port

6.3 Consumable items for the Unisys MyVision X

Item Description	Expected Life	Reorder Number
Ink Jet Cartridge	5 million characters (average life)	80-2118-877
Roller Ring Kit. Contains two of each: • Feeder Ring • Front Separator Ring • Rear Separator Ring	300,000 documents (average life) for each ring	75-0456-907
Micro-duster Air Cans, Disposable. Contains four cans.		75-0202-905

Reorder these items from Unisys Direct.

- In the United States, call 1-800-448-1424.
- In Canada, call 1-800-387-6127.
- For other countries, refer to <http://www.unisysdirect.com/locations>

